

Choose the language

English

Italiano

Deutsch

Français

Español

Sushi Sizes

Depth 90 cm Depth 35³/₈"

| | | |
|--|---|---------------------------|
| 90 | 150 cm 59" | → Fenix-NTM® → DEKTON® |
| | 150/187/224 cm 59/73 ⁵ / ₈ /88 ² / ₈ " | → Fenix-NTM® |
| | 150/187/224 cm 59/73 ⁵ / ₈ /88 ² / ₈ " | → DEKTON® |
| | 177 cm 69 ³ / ₄ " | → Fenix-NTM® → DEKTON® |
| | 177/214/251/288 cm 69 ³ / ₄ /84 ² / ₈ /98 ⁷ / ₈ /113 ³ / ₈ " | → Fenix-NTM® |
| | 177/214/251 cm 69 ³ / ₄ /84 ² / ₈ /98 ⁷ / ₈ " | → DEKTON® |
| | 200 cm 78 ³ / ₄ " | → Fenix-NTM® → DEKTON® |
| | 200/237/274 cm 78 ³ / ₄ /93 ¹ / ₄ /107 ⁷ / ₈ " | → Fenix-NTM® |
| | 200/237/274 cm 78 ³ / ₄ /93 ¹ / ₄ /107 ⁷ / ₈ " | → DEKTON® |
| | 220 cm 86 ⁵ / ₈ " | → Fenix-NTM® |
| 220/257/294 cm 86 ⁵ / ₈ /101 ² / ₈ /116 ¹ / ₈ " | → Fenix-NTM® | |

Depth 90 cm Depth 35³/₈"

| | | |
|----|---|--------------|
| 90 | 161 cm 63 ³ / ₈ " | → Fenix-NTM® |
| | 180 cm 70 ⁷ / ₈ " | → Fenix-NTM® |
| | 215 cm 84 ⁵ / ₈ " | → Fenix-NTM® |
| | 270 cm 106 ² / ₈ " | → Fenix-NTM® |

Bench

Depth 41 cm Depth 16¹/₈"

| | | |
|----|--|--------------|
| 41 | 123 cm 48 ³ / ₈ " | → Fenix-NTM® |
| | 144 cm 56 ³ / ₄ " | → Fenix-NTM® |
| | 162 cm 63 ⁷ / ₈ " | → Fenix-NTM® |

Depth 100 cm Depth 39³/₈"

| | | |
|-----|--|---------------------------|
| 100 | 177 cm 69 ³ / ₄ " | → Fenix-NTM® → DEKTON® |
| | 177/224/271 cm 69 ³ / ₄ /88 ² / ₈ /106 ³ / ₄ " | → Fenix-NTM® |
| | 177/214/251 cm 69 ³ / ₄ /84 ² / ₈ /98 ⁷ / ₈ " | → DEKTON® |
| | 200 cm 78 ³ / ₄ " | → Fenix-NTM® → DEKTON® |
| | 200/247/294 cm 78 ³ / ₄ /97 ² / ₈ /115 ³ / ₄ " | → Fenix-NTM® |
| | 200/237/274 cm 78 ³ / ₄ /93 ¹ / ₄ /107 ⁷ / ₈ " | → DEKTON® |
| | 220 cm 86 ⁵ / ₈ " | → Fenix-NTM® |
| | 220/267/314 cm 86 ⁵ / ₈ /105 ¹ / ₈ /123 ³ / ₄ " | → Fenix-NTM® |
| | 240 cm 94 ⁴ / ₈ " | → DEKTON® |
| | 280 cm 110 ² / ₈ " | → DEKTON® |

* = 3rd additional extension (on request)

Tops

Depth 136 cm
Depth 53 4/8"

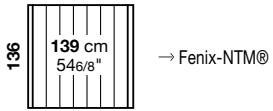

Fenix-NTM® black edge 10 mm thick

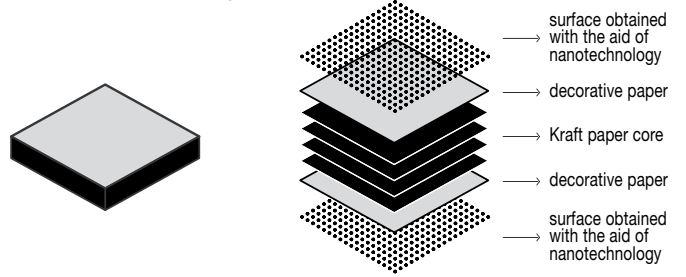

DEKTON® by Cosentino 8 mm thick



Sushi Fenix-NTM®

Extensible/Fixed - Depth 90 cm.

Leg finish:

Anodised aluminium

White lacquered aluminium (similar to RAL 9016)

"Fenix-NTM® London grey" lacquered aluminium (similar to RAL Design0805005)

"Fenix-NTM® Bromo grey" lacquered aluminium (similar to RAL 7012)

Black lacquered aluminium (similar to RAL 9004)

Olive green painted aluminium (colour ref. "Olive green PO08 polyurethane")

Finish of top/extensions:

Fenix-NTM® black edge (Kos white 0032, London grey 0718, Bromo grey 0724, Ingo black 0720)

→ For tables with codes marked with an asterisk (*), a third extension can be added to further increase the length.

→ Important: sizes and finishes marked with (!) require longer production lead time, about 6 weeks from the date of the order.

→ Tables that extend to more than 250 cm have a top that slightly bends, which complies with accepted quality standards.

→ Reinforced packaging, see inside of cover.

→ "Casper" protective cover, see page 74.

Extensible (►)

| Code | Length (L) | Depth | Legs | Top | Price in EURO | Packs | Vol.³ | Kg |
|----------|--|-------|-----------|----------------------|---------------|-------|-------|----|
| 01SUS07* | 150-187-224 | 90 | aluminium | Fenix black edge | | 3 | 0,41 | 71 |
| | | | lacquered | Fenix black edge | | | | |
| 01SUS06 | 177-214-251-288 <i>3rd standard extension</i> | 90 | aluminium | Fenix black edge | | 4 | 0,5 | 81 |
| | | | lacquered | Fenix black edge | | | | |
| 01SUS09* | 200-237-274 | 90 | aluminium | Fenix black edge | | 3 | 0,51 | 82 |
| | | | lacquered | Fenix black edge | | | | |
| 01SUS35* | 220-257-294 | 90 | aluminium | Fenix black edge (!) | | 3 | 0,55 | 88 |
| | | | lacquered | Fenix black edge (!) | | | | |

(*) 3rd additional extension

| Code | Length (L) | Extension | Price in EURO | Packs | Vol.³ | Kg |
|----------|------------|------------------|---------------|-------|-------|-----|
| 50SUS02A | 37,5 | Fenix black edge | | 1 | 0,025 | 6,5 |

Fixed (■)

| Code | Length (L) | Depth | Legs | Top | Price in EURO | Packs | Vol.³ | Kg |
|----------|------------|-------|-----------|----------------------|---------------|-------|-------|----|
| 01SUS07F | 150 | 90 | aluminium | Fenix black edge | | 1 | 0,36 | 46 |
| | | | lacquered | Fenix black edge | | | | |
| 01SUS06F | 177 | 90 | aluminium | Fenix black edge | | 1 | 0,42 | 52 |
| | | | lacquered | Fenix black edge | | | | |
| 01SUS64F | 200 | 90 | aluminium | Fenix black edge | | 1 | 0,46 | 57 |
| | | | lacquered | Fenix black edge | | | | |
| 01SUS35F | 220 | 90 | aluminium | Fenix black edge (!) | | 1 | 0,5 | 62 |
| | | | lacquered | Fenix black edge (!) | | | | |

Optionals

| Code | | Price in EURO | Packs | Vol.³ | Kg |
|---------|--|---------------|-------|-------|----|
| 02GTA02 |  legs height cut to size | | - | - | - |

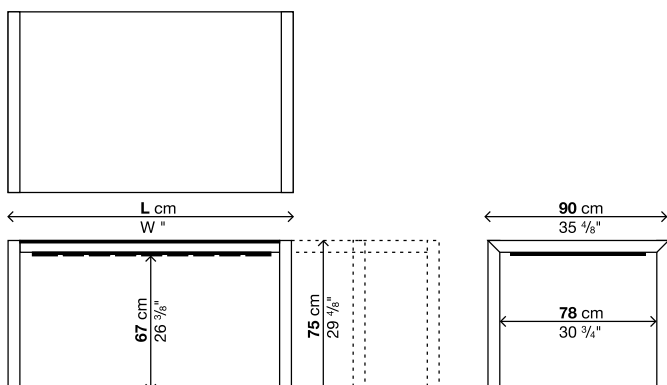

Sushi Fenix-NTM®

Extensible/Fixed - Depth 100 cm.

Leg finish:

Anodised aluminium

White lacquered aluminium (similar to RAL 9016)

"Fenix-NTM® London grey" lacquered aluminium (similar to RAL Design0805005)

"Fenix-NTM® Bromo grey" lacquered aluminium (similar to RAL 7012)

Black lacquered aluminium (similar to RAL 9004)

Olive green painted aluminium (colour ref. "Olive green PO08 polyurethane")

Finish of top:

Fenix-NTM® black edge (Kos white 0032, London grey 0718, Bromo grey 0724, Ingo black 0720)

→ For tables with codes marked with an asterisk (*), a third extension can be added to further increase the length.

→ Tables that extend to more than 250 cm have a top that slightly bends, which complies with accepted quality standards.

→ Reinforced packaging, see inside of cover.

→ "Casper" protective cover, see page 74.

Extensible (►)

| Code | Length (L) | Depth | Legs | Top | Price in EURO | Packs | Vol.³ | Kg |
|----------|-------------|-------|-----------|------------------|---------------|-------|-------|----|
| 01SUS02* | 177-224-271 | 100 | aluminium | Fenix black edge | | 3 | 0,52 | 85 |
| | | | lacquered | Fenix black edge | | | | |
| 01SUS36* | 200-247-294 | 100 | aluminium | Fenix black edge | | 3 | 0,57 | 92 |
| | | | lacquered | Fenix black edge | | | | |
| 01SUS05* | 220-267-314 | 100 | aluminium | Fenix black edge | | 3 | 0,62 | 98 |
| | | | lacquered | Fenix black edge | | | | |

(* 3rd additional extension

| Code | Length (L) | Extension | Price in EURO | Packs | Vol.³ | Kg |
|----------|------------|------------------|---------------|-------|-------|----|
| 50SUS06A | 33 | Fenix black edge | | 1 | 0,036 | 6 |

Fixed (||)

| Code | Length (L) | Depth | Legs | Top | Price in EURO | Packs | Vol.³ | Kg |
|----------|------------|-------|-----------|------------------|---------------|-------|-------|----|
| 01SUS02F | 177 | 100 | aluminium | Fenix black edge | | 1 | 0,45 | 56 |
| | | | lacquered | Fenix black edge | | | | |
| 01SUS08F | 200 | 100 | aluminium | Fenix black edge | | 1 | 0,5 | 62 |
| | | | lacquered | Fenix black edge | | | | |
| 01SUS05F | 220 | 100 | aluminium | Fenix black edge | | 1 | 0,55 | 67 |
| | | | lacquered | Fenix black edge | | | | |

Optionals

| Code | | Price in EURO | Packs | Vol.³ | Kg |
|---------|--|---------------|-------|-------|----|
| 02GTA02 |  legs height cut to size | - | - | - | - |

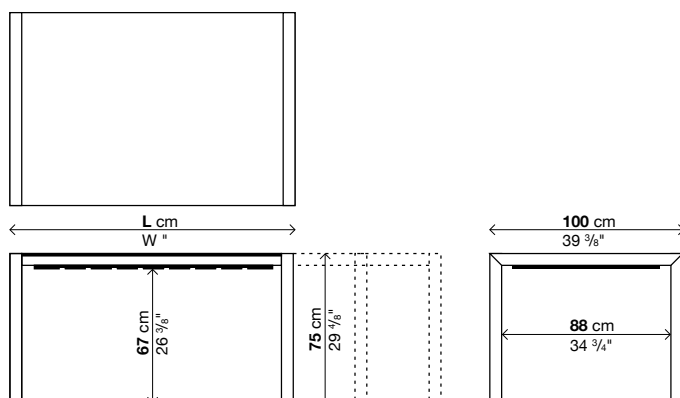

Sushi DEKTON® by Cosentino

Extensible/Fixed - Depth 90/100 cm.

Leg finish:

Anodised aluminium
 White lacquered aluminium (similar to RAL 9016)
 "Ventus grey" lacquered aluminium
 Olive green painted aluminium (colour ref. "Olive green PO08 polyurethane")

Finish of top:

DEKTON® Zenith white
 DEKTON® Ventus grey
 DEKTON® Aura (digital marble)

Finish of extensions:

White lacquered aluminium (similar to RAL 9016)
 "Ventus grey" lacquered aluminium

→ Important: the grain pattern reproduced on the surface of DEKTON® Aura (digital marble) tops is random, a special feature that makes each top unique and original. This characteristic implies possible differences to samples that are not to be considered imperfections or irregularities. Due to their random nature, uniform grain patterns cannot be requested.

→ Important: sizes and finishes marked with (I) require longer production lead time, about 6 weeks from the date of the order.

→ Tables that extend to more than 250 cm have a top that slightly bends, which complies with accepted quality standards.

→ Reinforced packaging, see inside of cover.

→ "Casper" protective cover, see page 74.

Extensible (►)

| Code | Length (L) | Depth | Legs | Top | Price in EURO | Packs | Vol.³ | Kg |
|---------|-------------|-------|-----------|------------|---------------|-------|-------|-----|
| 01SUS07 | 150-187-224 | 90 | aluminium | DEKTON (I) | | 3 | 0,41 | 89 |
| | | | lacquered | DEKTON (I) | | | | |
| 01SUS06 | 177-214-251 | 90 | aluminium | DEKTON (I) | | 3 | 0,5 | 102 |
| | | | lacquered | DEKTON (I) | | | | |
| 01SUS09 | 200-237-274 | 90 | aluminium | DEKTON (I) | | 3 | 0,51 | 105 |
| | | | lacquered | DEKTON (I) | | | | |
| 01SUS02 | 177-214-251 | 100 | aluminium | DEKTON (I) | | 3 | 0,52 | 108 |
| | | | lacquered | DEKTON (I) | | | | |
| 01SUS36 | 200-237-274 | 100 | aluminium | DEKTON (I) | | 3 | 0,57 | 118 |
| | | | lacquered | DEKTON (I) | | | | |

Fixed (II)

| Code | Length (L) | Depth | Legs | Top | Price in EURO | Packs | Vol.³ | Kg |
|----------|------------|-------|---------------------|------------|---------------|-------|-------|-----|
| 01SUS07F | 150 | 90 | aluminium lacquered | DEKTON (I) | | 1 | 0,36 | 60 |
| 01SUS06F | 177 | 90 | aluminium lacquered | DEKTON (I) | | 1 | 0,42 | 69 |
| 01SUS64F | 200 | 90 | aluminium lacquered | DEKTON (I) | | 1 | 0,46 | 76 |
| 01SUS02F | 177 | 100 | aluminium lacquered | DEKTON (I) | | 1 | 0,45 | 74 |
| 01SUS08F | 200 | 100 | aluminium lacquered | DEKTON (I) | | 1 | 0,5 | 83 |
| 01SUS09F | 240 | 100 | aluminium lacquered | DEKTON (I) | | 1 | 0,6 | 97 |
| 01SUS82F | 280 | 100 | aluminium lacquered | DEKTON (I) | | 1 | 0,69 | 115 |

Optionals

| Code | Depth | Price in EURO | Packs | Vol.³ | Kg |
|---------|--|---------------|-------|-------|----|
| 02GTA02 |  legs height cut to size | | - | - | - |

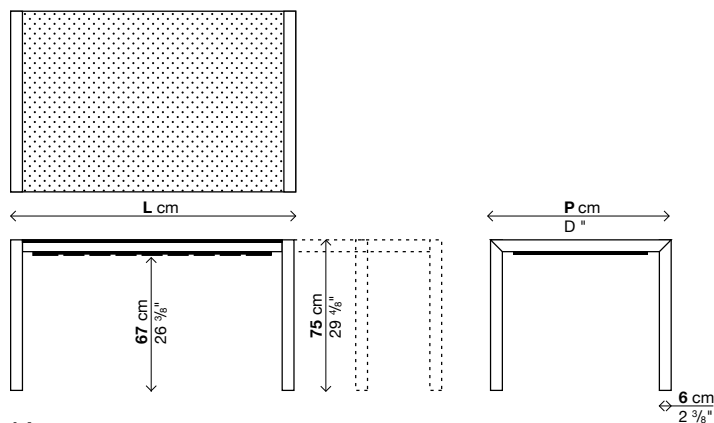

DEKTON®
by COSENTINO



HIGHLY UV RESISTANT



RESISTANT TO ABRASION



RESISTANT TO STAIN



MAXIMUM RESISTANCE TO FIRE AND HEAT



LOW WATER ABSORPTION



HIGH MECHANICAL RESISTANCE



COLOUR STABILITY



DIMENSIONAL STABILITY



FIREPROOF MATERIAL



Sushi

Legenda dimensioni

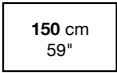
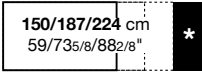
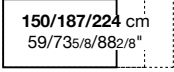
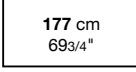
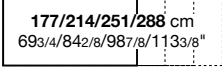
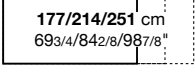
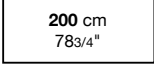
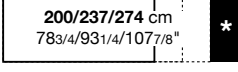
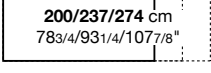
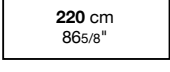
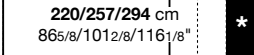
Prof. 90 cm
Depth 35³/₈"

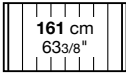
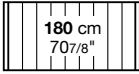

| | | |
|----|--|---------------------------|
| 90 |  | → Fenix-NTM® → DEKTON® |
| |  | → Fenix-NTM® |
| |  | → DEKTON® |
| |  | → Fenix-NTM® → DEKTON® |
| |  | → Fenix-NTM® |
| |  | → DEKTON® |
| |  | → Fenix-NTM® → DEKTON® |
| |  | → Fenix-NTM® |
| |  | → DEKTON® |
| |  | → Fenix-NTM® |
| |  | → Fenix-NTM® |

Prof. 90 cm
Depth 35³/₈"

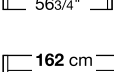

| | | |
|----|---|--------------|
| 90 |  | → Fenix-NTM® |
| |  | → Fenix-NTM® |
| |  | → Fenix-NTM® |
| |  | → Fenix-NTM® |

Panchetta

Prof. 41 cm
Depth 16¹/₈"

| | | |
|----|---|--------------|
| 41 |  | → Fenix-NTM® |
| |  | → Fenix-NTM® |
| |  | → Fenix-NTM® |

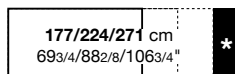
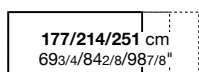
Prof. 100 cm
Depth 39³/₈"

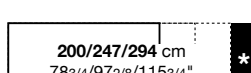
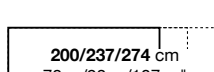
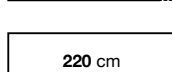
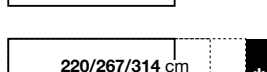
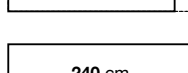
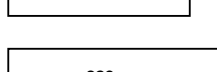
| | | |
|-----|---|---------------------------|
| 100 |  | → Fenix-NTM® → DEKTON® |
| |  | → Fenix-NTM® |
| |  | → DEKTON® |
| |  | → Fenix-NTM® → DEKTON® |
| |  | → Fenix-NTM® |
| |  | → DEKTON® |
| |  | → Fenix-NTM® |
| |  | → Fenix-NTM® |
| |  | → DEKTON® |
| |  | → DEKTON® |

* = 3° prolunga aggiuntiva (a richiesta)

Piani

Prof. 136 cm
Depth 53 4/8"

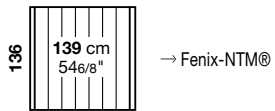

Fenix-NTM® bordo nero Sp. 10 mm

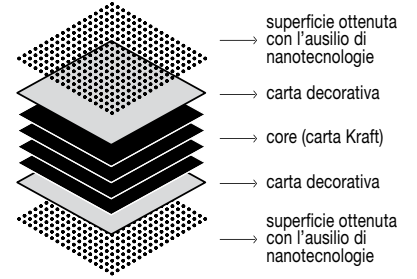
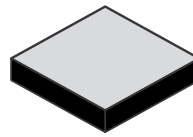

DEKTON® by Cosentino Sp. 8 mm

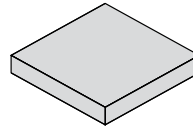

Dekton è una sofisticata miscela di materie prime utilizzate per la creazione di vetro, ceramica di ultima generazione e superfici in quarzo di altissima qualità

Sushi Fenix-NTM®

Allungabile/Fisso - Prof. 90 cm.

Finitura gambe:

Alluminio anodizzato

Alluminio verniciato bianco (simile al Ral 9016)

Alluminio verniciato "Fenix-NTM® grigio Londra" (simile al Ral Design0805005)

Alluminio verniciato "Fenix-NTM® grigio Bromo" (simile al Ral 7012)

Alluminio verniciato nero (simile al Ral 9004)

Alluminio verniciato verde oliva (rif. colore "Poliuretano verde oliva PO08")

Finitura piano/prolunghe:

Fenix-NTM® bordo nero (bianco Kos 0032, grigio Londra 0718, grigio Bromo 0724, nero Ingo 0720)

→ Nei tavoli con i codici contrassegnati con l'asterisco (*) c'è la possibilità di aggiungere la terza prolunga per aumentare ulteriormente l'allungo.

→ **Attenzione:** le misure o le finiture contrassegnate con (!) hanno tempi di produzione più lunghi, circa 6 settimane dalla data dell'ordine.

→ I tavoli che in estensione superano i 250 cm presentano una leggera flessione del piano, che rientra negli standard di qualità accettati.

→ Imballi rinforzati vedi interno di copertina.

→ **Copertura protettiva "Casper" vedi pag. 74.**

Allungabile (►)

| Codice | Lunghezza (L) | Prof. | Gambe | Piano | Prezzi EURO | coll: | m ² | Kg |
|-----------------|---|-------|-------------------------|--|-------------|-------|----------------|----|
| 01SUS07* | 150-187-224 | 90 | alluminio verniciato | Fenix bordo nero Fenix bordo nero | | 3 | 0,41 | 71 |
| 01SUS06 | 177-214-251-288 <i>3^a prolunga di serie</i> | 90 | alluminio verniciato | Fenix bordo nero Fenix bordo nero | | 4 | 0,5 | 81 |
| 01SUS09* | 200-237-274 | 90 | alluminio verniciato | Fenix bordo nero Fenix bordo nero | | 3 | 0,51 | 82 |
| 01SUS35* | 220-257-294 | 90 | alluminio verniciato | Fenix bordo nero (!) Fenix bordo nero (!) | | 3 | 0,55 | 88 |

(*) 3^a prolunga aggiuntiva

| Codice | Lunghezza (L) | Prolunga | Prezzi EURO | coll: | m ² | Kg |
|-----------------|---------------|------------------|-------------|-------|----------------|-----|
| 50SUS02A | 37,5 | Fenix bordo nero | | 1 | 0,025 | 6,5 |

Fisso (II)

| Codice | Lunghezza (L) | Prof. | Gambe | Piano | Prezzi EURO | coll: | m ² | Kg |
|-----------------|---------------|-------|-------------------------|--|-------------|-------|----------------|----|
| 01SUS07F | 150 | 90 | alluminio verniciato | Fenix bordo nero Fenix bordo nero | | 1 | 0,36 | 46 |
| 01SUS06F | 177 | 90 | alluminio verniciato | Fenix bordo nero Fenix bordo nero | | 1 | 0,42 | 52 |
| 01SUS64F | 200 | 90 | alluminio verniciato | Fenix bordo nero Fenix bordo nero | | 1 | 0,46 | 57 |
| 01SUS35F | 220 | 90 | alluminio verniciato | Fenix bordo nero (!) Fenix bordo nero (!) | | 1 | 0,5 | 62 |

Optionals

| Codice | | Prezzi EURO | coll: | m ² | Kg |
|----------------|--|-------------|-------|----------------|----|
| 02GTA02 |  taglio gambe a misura | | - | - | - |

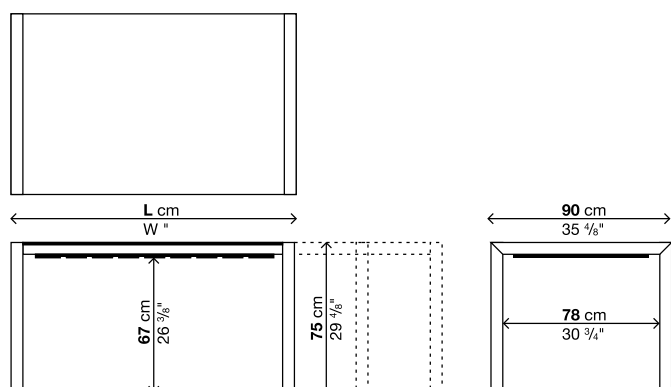

Sushi Fenix-NTM®

Allungabile/Fisso - Prof. 100 cm.

Finitura gambe:

Alluminio anodizzato

Alluminio verniciato bianco (simile al Ral 9016)

Alluminio verniciato "Fenix-NTM® grigio Londra" (simile al Ral Design0805005)

Alluminio verniciato "Fenix-NTM® grigio Bromo" (simile al Ral 7012)

Alluminio verniciato nero (simile al Ral 9004)

Alluminio verniciato verde oliva (rif. colore "Poliuretano verde oliva PO08")

Finitura piano:

Fenix-NTM® bordo nero (bianco Kos 0032, grigio Londra 0718, grigio Bromo 0724, nero Ingo 0720)

→ Nei tavoli con i codici contrassegnati con l'asterisco (*) c'è la possibilità di aggiungere la terza prolunga per aumentare ulteriormente l'allungo.

→ I tavoli che in estensione superano i 250 cm presentano una leggera flessione del piano, che rientra negli standard di qualità accettati.

→ Imballi rinforzati vedi interno di copertina.

→ Copertura protettiva "Casper" vedi pag. 74.

Allungabile (►)

| Codice | Lunghezza (L) | Prof. | Gambe | Piano | Prezzi EURO | coll. | m ² | Kg |
|----------|---------------|-------|----------------------|------------------|-------------|-------|----------------|----|
| 01SUS02* | 177-224-271 | 100 | alluminio verniciato | Fenix bordo nero | | 3 | 0,52 | 85 |
| 01SUS36* | 200-247-294 | 100 | alluminio verniciato | Fenix bordo nero | | 3 | 0,57 | 92 |
| 01SUS05* | 220-267-314 | 100 | alluminio verniciato | Fenix bordo nero | | 3 | 0,62 | 98 |

(*) 3^a prolunga aggiuntiva

| Codice | Lunghezza (L) | Prolunga | Prezzi EURO | coll. | m ² | Kg |
|----------|---------------|------------------|-------------|-------|----------------|----|
| 50SUS06A | 33 | Fenix bordo nero | | 1 | 0,036 | 6 |

Fisso (II)

| Codice | Lunghezza (L) | Prof. | Gambe | Piano | Prezzi EURO | coll. | m ² | Kg |
|----------|---------------|-------|----------------------|------------------|-------------|-------|----------------|----|
| 01SUS02F | 177 | 100 | alluminio verniciato | Fenix bordo nero | | 1 | 0,45 | 56 |
| 01SUS08F | 200 | 100 | alluminio verniciato | Fenix bordo nero | | 1 | 0,5 | 62 |
| 01SUS05F | 220 | 100 | alluminio verniciato | Fenix bordo nero | | 1 | 0,55 | 67 |

Optionals

| Codice | | Prezzi EURO | coll. | m ² | Kg |
|---------|--|-------------|-------|----------------|----|
| 02GTA02 |  taglio gambe a misura | - | - | - | - |

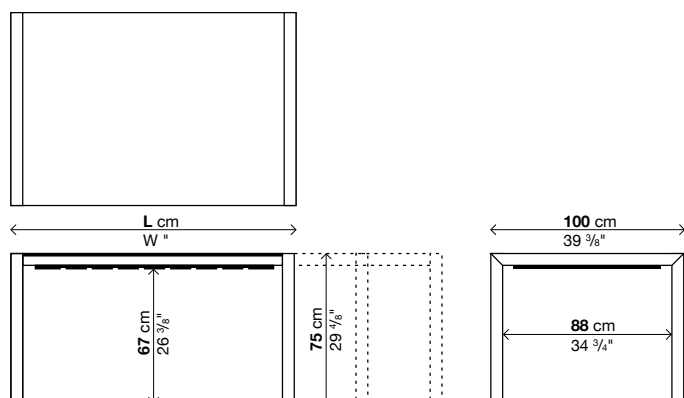

Sushi DEKTON® by Cosentino

Allungabile/Fisso - Prof. 90/100 cm.

Finitura gambe:

Alluminio anodizzato

Alluminio verniciato bianco (simile al Ral 9016)

Alluminio verniciato "grigio Ventus"

Alluminio verniciato verde oliva (rif. colore "Poliuretano verde oliva PO08")

Finitura piano:

DEKTON® bianco Zenith

DEKTON® grigio Ventus

DEKTON® Aura (marmo digitale)

Finitura prolunghe:

Alluminio verniciato bianco (simile al Ral 9016)

Alluminio verniciato "grigio Ventus"

→ *Attenzione: le venature riprodotte sulla superficie dei piani in DEKTON® Aura (marmo digitale) sono disposte in modo casuale, peculiarità che rende ciascun piano unico e non ripetibile. Questa caratteristica implica possibili differenze rispetto ai campioni, non contestabili quali imperfezioni o anomalie. In virtù della casualità della loro disposizione, non è possibile avere su richiesta venature più o meno omogenee.*

→ *Attenzione: le misure o le finiture contrassegnate con (!) hanno tempi di produzione più lunghi, circa 6 settimane dalla data dell'ordine.*

→ *I tavoli che in estensione superano i 250 cm presentano una leggera flessione del piano, che rientra negli standard di qualità accettati.*

→ *Imballi rinforzati vedi interno di copertina.*

→ **Copertura protettiva "Casper" vedi pag. 74.**

Allungabile (►)

| Codice | Lunghezza (L) | Prof. | Gambe | Piano | Prezzi EURO | colli | m ² | Kg |
|---------|---------------|-------|------------|------------|-------------|-------|----------------|----|
| 01SUS07 | 150-187-224 | 90 | alluminio | DEKTON (!) | 3 | 0,41 | 89 | |
| | | | verniciato | DEKTON (!) | | | | |
| 01SUS06 | 177-214-251 | 90 | alluminio | DEKTON (!) | 3 | 0,5 | 102 | |
| | | | verniciato | DEKTON (!) | | | | |
| 01SUS09 | 200-237-274 | 90 | alluminio | DEKTON (!) | 3 | 0,51 | 105 | |
| | | | verniciato | DEKTON (!) | | | | |
| 01SUS02 | 177-214-251 | 100 | alluminio | DEKTON (!) | 3 | 0,52 | 108 | |
| | | | verniciato | DEKTON (!) | | | | |
| 01SUS36 | 200-237-274 | 100 | alluminio | DEKTON (!) | 3 | 0,57 | 118 | |
| | | | verniciato | DEKTON (!) | | | | |

Fisso (II)

| Codice | Lunghezza (L) | Prof. | Gambe | Piano | Prezzi EURO | colli | m ² | Kg |
|----------|---------------|-------|----------------------|------------|-------------|-------|----------------|----|
| 01SUS07F | 150 | 90 | alluminio verniciato | DEKTON (!) | 1 | 0,36 | 60 | |
| 01SUS06F | 177 | 90 | alluminio verniciato | DEKTON (!) | 1 | 0,42 | 69 | |
| 01SUS64F | 200 | 90 | alluminio verniciato | DEKTON (!) | 1 | 0,46 | 76 | |
| 01SUS02F | 177 | 100 | alluminio verniciato | DEKTON (!) | 1 | 0,45 | 74 | |
| 01SUS08F | 200 | 100 | alluminio verniciato | DEKTON (!) | 1 | 0,5 | 83 | |
| 01SUS09F | 240 | 100 | alluminio verniciato | DEKTON (!) | 1 | 0,6 | 97 | |
| 01SUS82F | 280 | 100 | alluminio verniciato | DEKTON (!) | 1 | 0,69 | 115 | |

Optionals

| Codice | Prof | Prezzi EURO | colli | m ² | Kg |
|---------|--|-----------------------|-------|----------------|----|
| 02GTA02 |  | taglio gambe a misura | - | - | - |

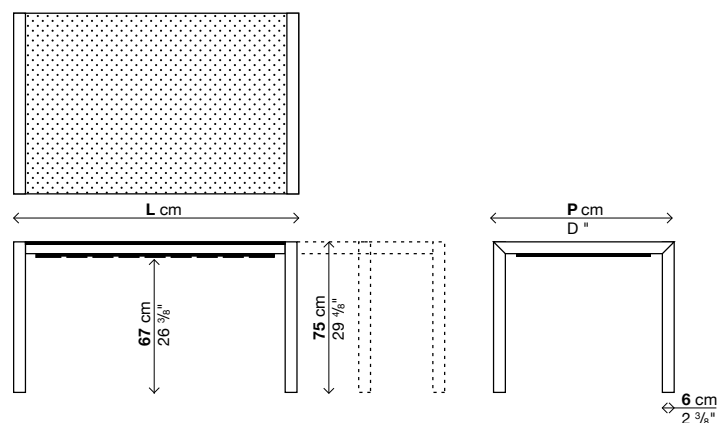

DEKTON®
by COSENTINO



HIGHLY UV RESISTANT



RESISTANT TO ABRASION



RESISTANT TO STAIN



MAXIMUM RESISTANCE TO FIRE AND HEAT



LOW WATER ABSORPTION



HIGH MECHANICAL RESISTANCE



COLOUR STABILITY



DIMENSIONAL STABILITY



FIREPROOF MATERIAL

Sushi

Größenübersicht

Breite 90 cm
Breite 35 3/8"

| | | |
|----|---|---------------------------|
| 90 | 150 cm 59" | → Fenix-NTM® → DEKTON® |
| | 150/187/224 cm 59/73 5/8/88 2/8" * | → Fenix-NTM® |
| | 150/187/224 cm 59/73 5/8/88 2/8" (gestrichelt) | → DEKTON® |
| | 177 cm 69 3/4" | → Fenix-NTM® → DEKTON® |
| | 177/214/251/288 cm 69 3/4/84 2/8/98 7/8/113 3/8" (gestrichelt) | → Fenix-NTM® |
| | 177/214/251 cm 69 3/4/84 2/8/98 7/8" (gestrichelt) | → DEKTON® |
| | 200 cm 78 3/4" | → Fenix-NTM® → DEKTON® |
| | 200/237/274 cm 78 3/4/93 1/4/107 7/8" * | → Fenix-NTM® |
| | 200/237/274 cm 78 3/4/93 1/4/107 7/8" (gestrichelt) | → DEKTON® |
| | 220 cm 86 5/8" | → Fenix-NTM® |
| | 220/257/294 cm 86 5/8/101 2/8/116 1/8" * | → Fenix-NTM® |

Breite 90 cm
Breite 35 3/8"

| | | |
|----|--------------------|--------------|
| 90 | 161 cm 63 3/8" | → Fenix-NTM® |
| | 180 cm 70 7/8" | → Fenix-NTM® |
| | 215 cm 84 5/8" | → Fenix-NTM® |
| | 270 cm 106 2/8" | → Fenix-NTM® |

Sitzbank

Breite 41 cm
Breite 16 1/8"

| | | |
|----|---------------------|--------------|
| 41 | 123 cm 48 3/8"] | → Fenix-NTM® |
| | 144 cm 56 3/4"] | → Fenix-NTM® |
| | 162 cm 63 7/8"] | → Fenix-NTM® |

Breite 100 cm
Breite 39 3/8"

| | | |
|-----|--|---------------------------|
| 100 | 177 cm 69 3/4" | → Fenix-NTM® → DEKTON® |
| | 177/224/271 cm 69 3/4/88 2/8/106 3/4" * | → Fenix-NTM® |
| | 177/214/251 cm 69 3/4/84 2/8/98 7/8" (gestrichelt) | → DEKTON® |
| | 200 cm 78 3/4" | → Fenix-NTM® → DEKTON® |
| | 200/247/294 cm 78 3/4/97 2/8/115 3/4" * | → Fenix-NTM® |
| | 200/237/274 cm 78 3/4/93 1/4/107 7/8" (gestrichelt) | → DEKTON® |
| | 220 cm 86 5/8" | → Fenix-NTM® |
| | 220/267/314 cm 86 5/8/105 1/8/123 3/4" * | → Fenix-NTM® |
| | 240 cm 94 1/8" | → DEKTON® |
| | 280 cm 110 2/8" | → DEKTON® |

* = 3. zusätzliche Verlängerung (auf Anfrage)

Platten

Breite 136 cm
Breite 53 4/8"

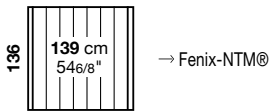

Fenix-NTM® schwarze Kante St. 10 mm

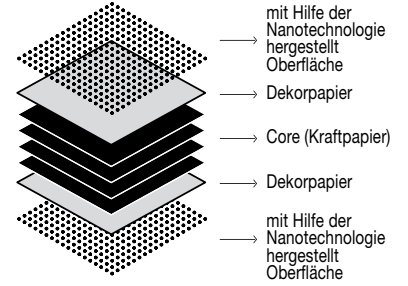
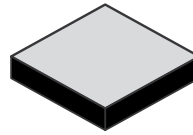

DEKTON® by Cosentino St. 8 mm

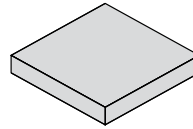

Dekton ist ein hoch entwickeltes Rohstoffgemisch, das für die Erzeugung von Glas, Keramik der letzten Generation und Quarzoberflächen mit höchster Qualität eingesetzt wird.

Sushi Fenix-NTM®

Erweiterbar/Fixmaße - Breite 90 cm.

Ausführung der Beine:

Eloxiertes Aluminium
 Weiß lackiertes Aluminium (farbähnlich wie Ral 9016)
 "Fenix-NTM® Grau London" lackiertes Aluminium (farbähnlich wie Ral Design0805005)
 "Fenix-NTM® Grau Bromo" lackiertes Aluminium (farbähnlich wie Ral 7012)
 Schwarz lackiertes Aluminium (farbähnlich wie Ral 9004)
 Olivgrün lackiertes Aluminium (farbähnlich wie "Polyurethan Olivgrün PO08")

Ausführung der Tischplatte/Verlängerungen:

Fenix-NTM® mit schwarzer Kante (Weiß Kos 0032, Grau London 0718, Grau Bromo 0724, Schwarz Ingo 0720)

→ Bei den Tischen, deren Artikelnummern mit Sternchen (*) markiert sind, ist das Hinzufügen einer dritten Verlängerung möglich, wodurch der Tisch noch größer wird.

→ Achtung: Die mit (!) gekennzeichneten Maße oder Ausführungen haben eine längere Produktionszeit: zirka 6 Wochen ab Auftragsdatum.

→ Jene Tische, die im ausgezogenen Zustand eine Länge von 250 cm überschreiten, weisen eine leichte Biegung der Platte auf, die jedoch innerhalb der festgelegten qualitativen Standards liegt.

→ Für verstärkte Verpackungen siehe Innenseite des Umschlags.

→ **Schutzhülle "Casper" siehe Seite 74.**

Erweiterbar (►)

| Art.-Nr. | Länge (L) | Breite | Beine | Platte | Preis in EURO | Kolli | V.m ³ | Kg |
|----------|--|--------|-----------|--------------------------|---------------|-------|------------------|----|
| 01SUS07* | 150-187-224 | 90 | Aluminium | Fenix schwarze Kante | | 3 | 0,41 | 71 |
| | | | Lackiert | Fenix schwarze Kante | | | | |
| 01SUS06 | 177-214-251-288 <small>dritte Verlängerung standard</small> | 90 | Aluminium | Fenix schwarze Kante | | 4 | 0,5 | 81 |
| | | | Lackiert | Fenix schwarze Kante | | | | |
| 01SUS09* | 200-237-274 | 90 | Aluminium | Fenix schwarze Kante | | 3 | 0,51 | 82 |
| | | | Lackiert | Fenix schwarze Kante | | | | |
| 01SUS35* | 220-257-294 | 90 | Aluminium | Fenix schwarze Kante (!) | | 3 | 0,55 | 88 |
| | | | Lackiert | Fenix schwarze Kante (!) | | | | |

(*) 3. zusätzliche Verlängerung

| Art.-Nr. | Länge (L) | Verlängerung | Preis in EURO | Kolli | V.m ³ | Kg |
|----------|-----------|----------------------|---------------|-------|------------------|-----|
| 50SUS02A | 37,5 | Fenix schwarze Kante | | 1 | 0,025 | 6,5 |

Fixmaße (II)

| Art.-Nr. | Länge (L) | Breite | Beine | Platte | Preis in EURO | Kolli | V.m ³ | Kg |
|----------|-----------|--------|-----------|--------------------------|---------------|-------|------------------|----|
| 01SUS07F | 150 | 90 | Aluminium | Fenix schwarze Kante | | 1 | 0,36 | 46 |
| | | | Lackiert | Fenix schwarze Kante | | | | |
| 01SUS06F | 177 | 90 | Aluminium | Fenix schwarze Kante | | 1 | 0,42 | 52 |
| | | | Lackiert | Fenix schwarze Kante | | | | |
| 01SUS64F | 200 | 90 | Aluminium | Fenix schwarze Kante | | 1 | 0,46 | 57 |
| | | | Lackiert | Fenix schwarze Kante | | | | |
| 01SUS35F | 220 | 90 | Aluminium | Fenix schwarze Kante (!) | | 1 | 0,5 | 62 |
| | | | Lackiert | Fenix schwarze Kante (!) | | | | |

Optionals

| Art.-Nr. | | | Preis in EURO | Kolli | V.m ³ | Kg |
|----------|--|------------------------------|---------------|-------|------------------|----|
| 02GTA02 |  | Zuschnitt der Beine nach Maß | | - | - | - |

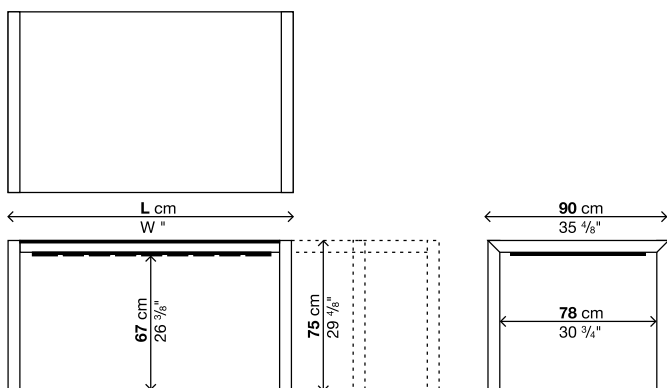

Sushi Fenix-NTM®

Erweiterbar/Fixmaße - Breite 100 cm.

Ausführung der Beine:

Eloxiertes Aluminium

Weiß lackiertes Aluminium (farbähnlich wie Ral 9016)

"Fenix-NTM® Grau London" lackiertes Aluminium (farbähnlich wie Ral Design0805005)

"Fenix-NTM® Grau Bromo" lackiertes Aluminium (farbähnlich wie Ral 7012)

Schwarz lackiertes Aluminium (farbähnlich wie Ral 9004)

Olivgrün lackiertes Aluminium (farbähnlich wie "Polyurethan Olivgrün PO08")

Ausführung der Tischplatte:

Fenix-NTM® mit schwarzer Kante (Weiß Kos 0032, Grau London 0718,

Grau Bromo 0724, Schwarz Ingo 0720)

→ Bei den Tischen, deren Artikelnummern mit Sternchen (*) markiert sind, ist das Hinzufügen einer dritten Verlängerung möglich, wodurch der Tisch noch größer wird.

→ Jene Tische, die im ausgezogenen Zustand eine Länge von 250 cm überschreiten, weisen eine leichte Biegung der Platte auf, die jedoch innerhalb der festgelegten qualitativen Standards liegt.

→ Für verstärkte Verpackungen siehe Innenseite des Umschlags.

→ **Schutzhülle "Casper" siehe Seite 74.**

Erweiterbar (►)

| Art.-Nr. | Länge (L) | Breite | Beine | Platte | Preis in EURO | Kolli | V.m³ | Kg |
|-----------------|-------------|--------|-----------|----------------------|---------------|-------|------|----|
| 01SUS02* | 177-224-271 | 100 | Aluminium | Fenix schwarze Kante | | 3 | 0,52 | 85 |
| | | | Lackiert | Fenix schwarze Kante | | | | |
| 01SUS36* | 200-247-294 | 100 | Aluminium | Fenix schwarze Kante | | 3 | 0,57 | 92 |
| | | | Lackiert | Fenix schwarze Kante | | | | |
| 01SUS05* | 220-267-314 | 100 | Aluminium | Fenix schwarze Kante | | 3 | 0,62 | 98 |
| | | | Lackiert | Fenix schwarze Kante | | | | |

(*) 3. zusätzliche Verlängerung

| Art.-Nr. | Länge (L) | Verlängerung | Preis in EURO | Kolli | V.m³ | Kg |
|-----------------|-----------|----------------------|---------------|-------|-------|----|
| 50SUS06A | 33 | Fenix schwarze Kante | | 1 | 0,036 | 6 |

Fixmaße (II)

| Art.-Nr. | Länge (L) | Breite | Beine | Platte | Preis in EURO | Kolli | V.m³ | Kg |
|-----------------|-----------|--------|-----------|----------------------|---------------|-------|------|----|
| 01SUS02F | 177 | 100 | Aluminium | Fenix schwarze Kante | | 1 | 0,45 | 56 |
| | | | Lackiert | Fenix schwarze Kante | | | | |
| 01SUS08F | 200 | 100 | Aluminium | Fenix schwarze Kante | | 1 | 0,5 | 62 |
| | | | Lackiert | Fenix schwarze Kante | | | | |
| 01SUS05F | 220 | 100 | Aluminium | Fenix schwarze Kante | | 1 | 0,55 | 67 |
| | | | Lackiert | Fenix schwarze Kante | | | | |

Optionals

| Art.-Nr. | | | Preis in EURO | Kolli | V.m³ | Kg |
|----------------|--|------------------------------|---------------|-------|------|----|
| 02GTA02 |  | Zuschnitt der Beine nach Maß | | - | - | - |

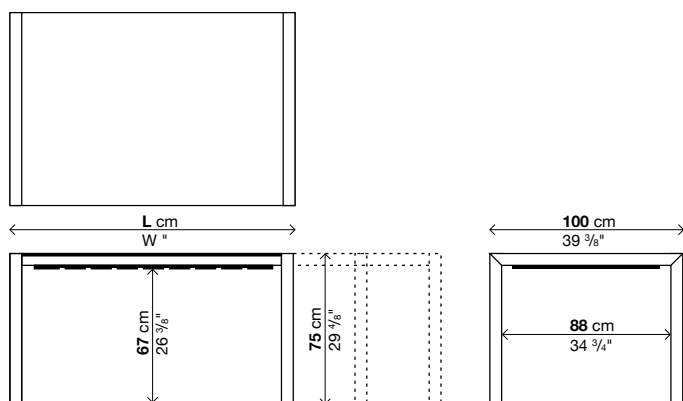

Sushi DEKTON® by Cosentino

Erweiterbar/Fixmaße - Breite 90/100 cm.

Ausführung der Beine:

Eloxiertes Aluminium
 Weiß lackiertes Aluminium (farbähnlich wie Ral 9016)
 "Grau Ventus" lackiertes Aluminium
 Olivgrün lackiertes Aluminium (farbähnlich wie "Polyurethan Olivgrün PO08")

Ausführung der Tischplatte:

DEKTON® weiß Zenith
 DEKTON® Grau Ventus
 DEKTON® Aura (digitaler Marmor)

Ausführung der Verlängerungen:

Weiß lackiertes Aluminium (farbähnlich wie Ral 9016)
 "Grau Ventus" lackiertes Aluminium

→ Achtung: Die auf der Oberfläche der Platten aus DEKTON® Aura (digitaler Marmor) nachgebildeten Aderungen werden auf zufällige Art und Weise angebracht, eine Besonderheit, die jede Platte einzigartig und unwiederholbar macht. Dieses Merkmal führt zu eventuellen Unterschieden bei den Mustern, kann jedoch nicht als Imperfektion oder Anomalie beanstandet werden. Aufgrund der gewollten Zufälligkeit ist auch auf Anfrage keine Erzeugung einer mehr oder weniger gleichmäßigen Aderung möglich.

→ Achtung: Die mit (!) gekennzeichneten Maße oder Ausführungen haben eine längere Produktionszeit: zirka 6 Wochen ab Auftragsdatum.

→ Jene Tische, die im ausgezogenen Zustand eine Länge von 250 cm überschreiten, weisen eine leichte Biegung der Platte auf, die jedoch innerhalb der festgelegten qualitativen Standards liegt.

→ Für verstärkte Verpackungen siehe Innenseite des Umschlags.

→ **Schutzhülle "Casper" siehe Seite 74.**

Erweiterbar (▶)

| Art.-Nr. | Länge (L) | Breite | Beine | Platte | Preis in EURO | Kolli | V.m ³ | Kg |
|----------|-------------|--------|-----------|------------|---------------|-------|------------------|-----|
| 01SUS07 | 150-187-224 | 90 | Aluminium | DEKTON (!) | | 3 | 0,41 | 89 |
| | | | Lackiert | DEKTON (!) | | | | |
| 01SUS06 | 177-214-251 | 90 | Aluminium | DEKTON (!) | | 3 | 0,5 | 102 |
| | | | Lackiert | DEKTON (!) | | | | |
| 01SUS09 | 200-237-274 | 90 | Aluminium | DEKTON (!) | | 3 | 0,51 | 105 |
| | | | Lackiert | DEKTON (!) | | | | |
| 01SUS02 | 177-214-251 | 100 | Aluminium | DEKTON (!) | | 3 | 0,52 | 108 |
| | | | Lackiert | DEKTON (!) | | | | |
| 01SUS36 | 200-237-274 | 100 | Aluminium | DEKTON (!) | | 3 | 0,57 | 118 |
| | | | Lackiert | DEKTON (!) | | | | |

Fixmaße (II)

| Art.-Nr. | Länge (L) | Breite | Beine | Platte | Preis in EURO | Kolli | V.m ³ | Kg |
|----------|-----------|--------|-----------------------|--------------------------|---------------|-------|------------------|-----|
| 01SUS07F | 150 | 90 | Aluminium Lackiert | DEKTON (!) DEKTON (!) | | 1 | 0,36 | 60 |
| 01SUS06F | 177 | 90 | Aluminium Lackiert | DEKTON (!) DEKTON (!) | | 1 | 0,42 | 69 |
| 01SUS64F | 200 | 90 | Aluminium Lackiert | DEKTON (!) DEKTON (!) | | 1 | 0,46 | 76 |
| 01SUS02F | 177 | 100 | Aluminium Lackiert | DEKTON (!) DEKTON (!) | | 1 | 0,45 | 74 |
| 01SUS08F | 200 | 100 | Aluminium Lackiert | DEKTON (!) DEKTON (!) | | 1 | 0,5 | 83 |
| 01SUS09F | 240 | 100 | Aluminium Lackiert | DEKTON (!) DEKTON (!) | | 1 | 0,6 | 97 |
| 01SUS82F | 280 | 100 | Aluminium Lackiert | DEKTON (!) DEKTON (!) | | 1 | 0,69 | 115 |

Optionals

| Art.-Nr. | Breite | Preis in EURO | Kolli | V.m ³ | Kg |
|----------|--|------------------------------|-------|------------------|----|
| 02GTA02 |  | Zuschnitt der Beine nach Maß | - | - | - |

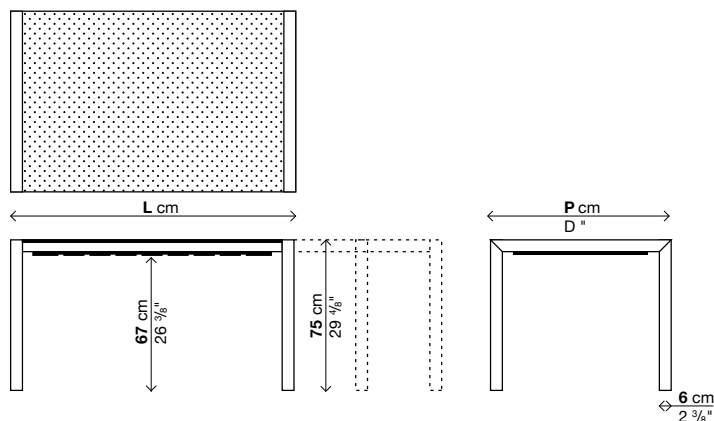

DEKTON®
by COSENTINO



HIGHLY UV RESISTANT



RESISTANT TO ABRASION



RESISTANT TO STAIN



MAXIMUM RESISTANCE TO FIRE AND HEAT



LOW WATER ABSORPTION



HIGH MECHANICAL RESISTANCE



COLOUR STABILITY



DIMENSIONAL STABILITY



FIREPROOF MATERIAL

Sushi

Dimensions

Prof. 90 cm
Prof. 35³/₈"

| | | |
|--|---|---------------------------|
| 90 | 150 cm 59" | → Fenix-NTM® → DEKTON® |
| | 150/187/224 cm 59/73 ⁵ / ₈ /88 ² / ₈ " | → Fenix-NTM® |
| | 150/187/224 cm 59/73 ⁵ / ₈ /88 ² / ₈ " | → DEKTON® |
| | 177 cm 69 ³ / ₄ " | → Fenix-NTM® → DEKTON® |
| | 177/214/251/288 cm 69 ³ / ₄ /84 ² / ₈ /98 ⁷ / ₈ /113 ³ / ₈ " | → Fenix-NTM® |
| | 177/214/251 cm 69 ³ / ₄ /84 ² / ₈ /98 ⁷ / ₈ " | → DEKTON® |
| | 200 cm 78 ³ / ₄ " | → Fenix-NTM® → DEKTON® |
| | 200/237/274 cm 78 ³ / ₄ /93 ¹ / ₄ /107 ⁷ / ₈ " | → Fenix-NTM® |
| | 200/237/274 cm 78 ³ / ₄ /93 ¹ / ₄ /107 ⁷ / ₈ " | → DEKTON® |
| | 220 cm 86 ⁵ / ₈ " | → Fenix-NTM® |
| 220/257/294 cm 86 ⁵ / ₈ /101 ² / ₈ /116 ¹ / ₈ " | → Fenix-NTM® | |

Prof. 90 cm
Prof. 35³/₈"

| | | |
|----|---|--------------|
| 90 | 161 cm 63 ³ / ₈ " | → Fenix-NTM® |
| | 180 cm 70 ⁷ / ₈ " | → Fenix-NTM® |
| | 215 cm 84 ⁵ / ₈ " | → Fenix-NTM® |
| | 270 cm 106 ² / ₈ " | → Fenix-NTM® |

Banc

Prof. 41 cm
Prof. 16¹/₈"

| | | |
|----|--|--------------|
| 41 | 123 cm 48 ³ / ₈ " | → Fenix-NTM® |
| | 144 cm 56 ³ / ₄ " | → Fenix-NTM® |
| | 162 cm 63 ⁷ / ₈ " | → Fenix-NTM® |

Prof. 100 cm
Prof. 39³/₈"

| | | |
|-----|--|---------------------------|
| 100 | 177 cm 69 ³ / ₄ " | → Fenix-NTM® → DEKTON® |
| | 177/224/271 cm 69 ³ / ₄ /88 ² / ₈ /106 ³ / ₄ " | → Fenix-NTM® |
| | 177/214/251 cm 69 ³ / ₄ /84 ² / ₈ /98 ⁷ / ₈ " | → DEKTON® |
| | 200 cm 78 ³ / ₄ " | → Fenix-NTM® → DEKTON® |
| | 200/247/294 cm 78 ³ / ₄ /97 ² / ₈ /115 ³ / ₄ " | → Fenix-NTM® |
| | 200/237/274 cm 78 ³ / ₄ /93 ¹ / ₄ /107 ⁷ / ₈ " | → DEKTON® |
| | 220 cm 86 ⁵ / ₈ " | → Fenix-NTM® |
| | 220/267/314 cm 86 ⁵ / ₈ /105 ¹ / ₈ /123 ³ / ₄ " | → Fenix-NTM® |
| | 240 cm 94 ⁴ / ₈ " | → DEKTON® |
| | 280 cm 110 ² / ₈ " | → DEKTON® |

* = 3ème rallonge supplémentaire (sur demande)

Plateaux

Prof. 136 cm
Prof. 53 4/8"

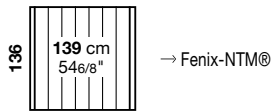

Fenix-NTM® chant noir Ép. 10 mm

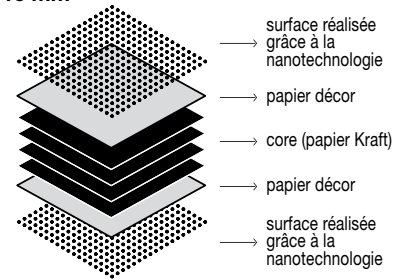
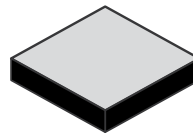

DEKTON® by Cosentino Ép. 8 mm

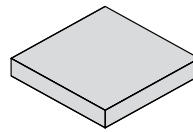

Dekton est un mélange sophistiqué de matières premières utilisées pour la fabrication du verre, de céramique de dernière génération et de surfaces en quartz de très haute qualité

Sushi Fenix-NTM®

Extensible/Fixe - Prof. 90 cm.

Finition piètement:

Aluminium anodisé

Aluminium laqué blanc (semblable au Ral 9016)

Aluminium laqué "Fenix-NTM® gris Londres" (semblable au Ral Design0805005)

Aluminium laqué "Fenix-NTM® gris Bromo" (semblable au Ral 7012)

Aluminium laqué noir (semblable au Ral 9004)

Aluminium laqué vert olive (coloris de référence "Polyuréthane vert olive PO08")

Finition du plateau/rallonges:

Fenix-NTM® chant noir (blanc Kos 0032, gris Londres 0718, gris

Bromo 0724, noir Ingo 0720)

→ Pour les modèles de table marqués d'un astérisque (*), il est possible d'ajouter une troisième rallonge pour augmenter davantage l'extension.

→ Attention: les dimensions et les finitions marquées par un point d'exclamation (!) ont des délais de production plus longs (environ 6 semaines à partir de la date de la commande).

→ Les tables qui une fois allongées font plus de 250 cm présentent une légère flexion du plateau qui respecte les standards de qualité acceptés.

→ Pour emballages renforcés, voir intérieur de la couverture.

→ Housse de protection "Casper", voir page 74.

Extensible (►)

| Code | Longueur (L) | Prof. | Pieds | Plateau | Prix en EURO | Coils | m ² | Kg |
|----------|---|-------|--------------------|--|--------------|-------|----------------|----|
| 01SUS07* | 150-187-224 | 90 | aluminium laqué | Fenix chant noir Fenix chant noir | | 3 | 0,41 | 71 |
| 01SUS06 | 177-214-251-288 <small>3ème extension compris standard</small> | 90 | aluminium laqué | Fenix chant noir Fenix chant noir | | 4 | 0,5 | 81 |
| 01SUS09* | 200-237-274 | 90 | aluminium laqué | Fenix chant noir Fenix chant noir | | 3 | 0,51 | 82 |
| 01SUS35* | 220-257-294 | 90 | aluminium laqué | Fenix chant noir (!) Fenix chant noir (!) | | 3 | 0,55 | 88 |

(*) 3ème rallonge supplémentaire

| Code | Longueur (L) | Rallonge | Prix en EURO | Coils | m ² | Kg |
|----------|--------------|------------------|--------------|-------|----------------|-----|
| 50SUS02A | 37,5 | Fenix chant noir | | 1 | 0,025 | 6,5 |

Fixe (II)

| Code | Longueur (L) | Prof. | Pieds | Plateau | Prix en EURO | Coils | m ² | Kg |
|----------|--------------|-------|--------------------|--|--------------|-------|----------------|----|
| 01SUS07F | 150 | 90 | aluminium laqué | Fenix chant noir Fenix chant noir | | 1 | 0,36 | 46 |
| 01SUS06F | 177 | 90 | aluminium laqué | Fenix chant noir Fenix chant noir | | 1 | 0,42 | 52 |
| 01SUS64F | 200 | 90 | aluminium laqué | Fenix chant noir Fenix chant noir | | 1 | 0,46 | 57 |
| 01SUS35F | 220 | 90 | aluminium laqué | Fenix chant noir (!) Fenix chant noir (!) | | 1 | 0,5 | 62 |

Optionals

| Code | | Prix en EURO | Coils | m ² | Kg |
|---------|---|--------------|-------|----------------|----|
| 02GTA02 |  coupe des pieds sur mesure | | - | - | - |

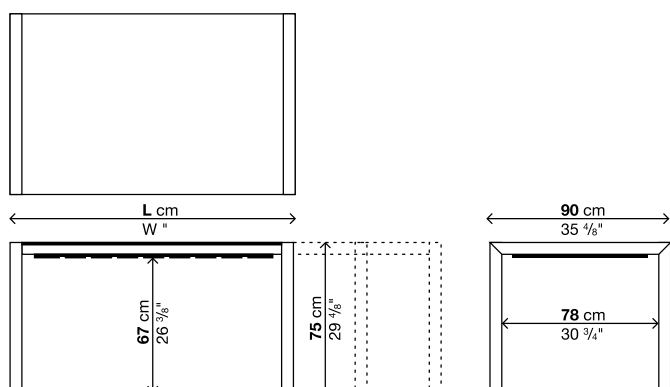

Sushi Fenix-NTM®

Extensible/Fixe - Prof. 100 cm.

Finition piètement:

Aluminium anodisé

Aluminium laqué blanc (semblable au Ral 9016)

Aluminium laqué "Fenix-NTM® gris Londres" (semblable au Ral Design0805005)

Aluminium laqué "Fenix-NTM® gris Bromo" (semblable au Ral 7012)

Aluminium laqué noir (semblable au Ral 9004)

Aluminium laqué vert olive (coloris de référence "Polyuréthane vert olive PO08")

Finition du plateau:

Fenix-NTM® chant noir (blanc Kos 0032, gris Londres 0718, gris

Bromo 0724, noir Ingo 0720)

→ Pour les modèles de table marqués d'un astérisque (*), il est possible d'ajouter une troisième rallonge pour augmenter davantage l'extension.

→ Les tables qui une fois allongées font plus de 250 cm présentent une légère flexion du plateau qui respecte les standards de qualité acceptés.

→ Pour emballages renforcés, voir intérieur de la couverture.

→ **Housse de protection "Casper", voir page 74.**

Extensible (►)

| Code | Longueur (L) | Prof. | Pieds | Plateau | Prix en EURO | Coils | m ² | Kg |
|----------|--------------|-------|-----------|------------------|--------------|-------|----------------|----|
| 01SUS02* | 177-224-271 | 100 | aluminium | Fenix chant noir | | 3 | 0,52 | 85 |
| | | | laqué | Fenix chant noir | | | | |
| 01SUS36* | 200-247-294 | 100 | aluminium | Fenix chant noir | | 3 | 0,57 | 92 |
| | | | laqué | Fenix chant noir | | | | |
| 01SUS05* | 220-267-314 | 100 | aluminium | Fenix chant noir | | 3 | 0,62 | 98 |
| | | | laqué | Fenix chant noir | | | | |

(*) 3ème rallonge supplémentaire

| Code | Longueur (L) | Rallonge | Prix en EURO | Coils | m ² | Kg |
|----------|--------------|------------------|--------------|-------|----------------|----|
| 50SUS06A | 33 | Fenix chant noir | | 1 | 0,036 | 6 |

Fixe (II)

| Code | Longueur (L) | Prof. | Pieds | Plateau | Prix en EURO | Coils | m ² | Kg |
|----------|--------------|-------|-----------|------------------|--------------|-------|----------------|----|
| 01SUS02F | 177 | 100 | aluminium | Fenix chant noir | | 1 | 0,45 | 56 |
| | | | laqué | Fenix chant noir | | | | |
| 01SUS08F | 200 | 100 | aluminium | Fenix chant noir | | 1 | 0,5 | 62 |
| | | | laqué | Fenix chant noir | | | | |
| 01SUS05F | 220 | 100 | aluminium | Fenix chant noir | | 1 | 0,55 | 67 |
| | | | laqué | Fenix chant noir | | | | |

Optionals

| Code | | Prix en EURO | Coils | m ² | Kg |
|---------|---|--------------|-------|----------------|----|
| 02GTA02 |  coupe des pieds sur mesure | - | - | - | - |

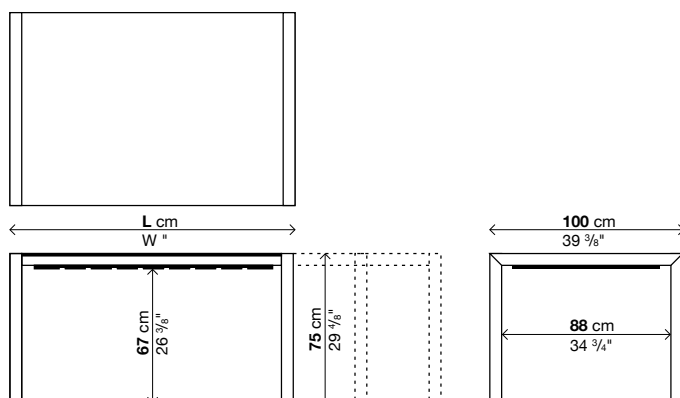

Sushi DEKTON® by Cosentino

Extensible/Fixe - Prof. 90/100 cm.

Finition piètement:

Aluminium anodisé
 Aluminium laqué blanc (semblable au Ral 9016)
 Aluminium laqué "gris Ventus"
 Aluminium laqué vert olive (coloris de référence "Polyuréthane vert olive PO08")

Finition du plateau:

DEKTON® blanc Zenith
 DEKTON® gris Ventus
 DEKTON® Aura (effet marbre)

Finition des rallonges:

Aluminium laqué blanc (semblable au Ral 9016)
 Aluminium laqué "gris Ventus"

→ Attention: les veines imprimées sur la surface des plateaux en DEKTON® Aura (effet marbre) sont disposées de façon aléatoire, ce qui rend chaque plateau unique puisque une reproduction exacte est bien entendu impossible. Cette caractéristique implique qu'il pourrait y avoir des différences par rapport aux échantillons, mais celles-ci ne pourront en aucun cas faire l'objet de contestations au titre d'imperfections ou d'anomalies. Du fait que l'impression réalisée est du type aléatoire, aucune demande concernant l'homogénéité des veines ne pourra être acceptée.

→ Attention: les dimensions et les finitions marquées par un point d'exclamation (!) ont des délais de production plus longs (environ 6 semaines à partir de la date de la commande).

→ Les tables qui une fois allongées font plus de 250 cm présentent une légère flexion du plateau qui respecte les standards de qualité acceptés.

→ Pour emballages renforcés, voir intérieur de la couverture.

→ Housse de protection "Casper", voir page 74.

Extensible (►)

| Code | Longueur (L) | Prof. | Pieds | Plateau | Prix en EURO | Coils | m ² | Kg |
|---------|--------------|-------|-----------|------------|--------------|-------|----------------|----|
| 01SUS07 | 150-187-224 | 90 | aluminium | DEKTON (!) | 3 | 0,41 | 89 | |
| | | | laqué | DEKTON (!) | | | | |
| 01SUS06 | 177-214-251 | 90 | aluminium | DEKTON (!) | 3 | 0,5 | 102 | |
| | | | laqué | DEKTON (!) | | | | |
| 01SUS09 | 200-237-274 | 90 | aluminium | DEKTON (!) | 3 | 0,51 | 105 | |
| | | | laqué | DEKTON (!) | | | | |
| 01SUS02 | 177-214-251 | 100 | aluminium | DEKTON (!) | 3 | 0,52 | 108 | |
| | | | laqué | DEKTON (!) | | | | |
| 01SUS36 | 200-237-274 | 100 | aluminium | DEKTON (!) | 3 | 0,57 | 118 | |
| | | | laqué | DEKTON (!) | | | | |

Fixe (II)

| Code | Longueur (L) | Prof. | Pieds | Plateau | Prix en EURO | Coils | m ² | Kg |
|----------|--------------|-------|-----------|------------|--------------|-------|----------------|----|
| 01SUS07F | 150 | 90 | aluminium | DEKTON (!) | 1 | 0,36 | 60 | |
| | | | laqué | DEKTON (!) | | | | |
| 01SUS06F | 177 | 90 | aluminium | DEKTON (!) | 1 | 0,42 | 69 | |
| | | | laqué | DEKTON (!) | | | | |
| 01SUS64F | 200 | 90 | aluminium | DEKTON (!) | 1 | 0,46 | 76 | |
| | | | laqué | DEKTON (!) | | | | |
| 01SUS02F | 177 | 100 | aluminium | DEKTON (!) | 1 | 0,45 | 74 | |
| | | | laqué | DEKTON (!) | | | | |
| 01SUS08F | 200 | 100 | aluminium | DEKTON (!) | 1 | 0,5 | 83 | |
| | | | laqué | DEKTON (!) | | | | |
| 01SUS09F | 240 | 100 | aluminium | DEKTON (!) | 1 | 0,6 | 97 | |
| | | | laqué | DEKTON (!) | | | | |
| 01SUS82F | 280 | 100 | aluminium | DEKTON (!) | 1 | 0,69 | 115 | |
| | | | laqué | DEKTON (!) | | | | |

Optionals

| Code | Prof. | Prix en EURO | Coils | m ² | Kg |
|---------|--|----------------------------|-------|----------------|----|
| 02GTA02 |  | coupe des pieds sur mesure | - | - | - |

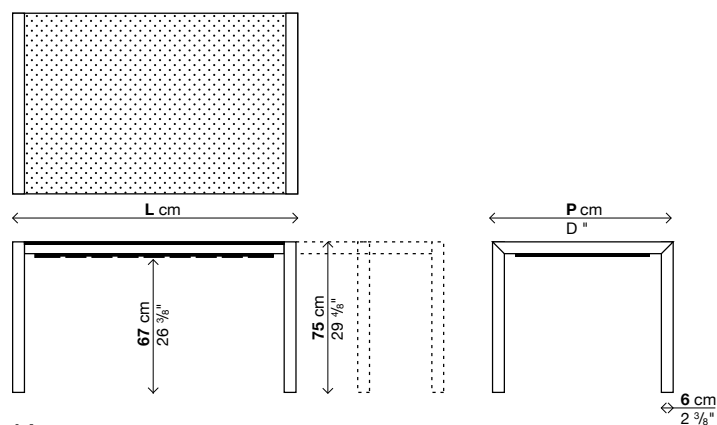

HIGHLY UV RESISTANT



RESISTANT TO ABRASION



RESISTANT TO STAIN



MAXIMUM RESISTANCE TO FIRE AND HEAT



LOW WATER ABSORPTION



HIGH MECHANICAL RESISTANCE



COLOUR STABILITY



DIMENSIONAL STABILITY



FIREPROOF MATERIAL

Sushi

Dimensiones

Prof. 90 cm
Prof. 35³/₈"

| | | |
|--|---|---------------------------|
| 90 | 150 cm 59" | → Fenix-NTM® → DEKTON® |
| | 150/187/224 cm 59/73 ⁵ / ₈ /88 ² / ₈ " | → Fenix-NTM® |
| | 150/187/224 cm 59/73 ⁵ / ₈ /88 ² / ₈ " | → DEKTON® |
| | 177 cm 69 ³ / ₄ " | → Fenix-NTM® → DEKTON® |
| | 177/214/251/288 cm 69 ³ / ₄ /84 ² / ₈ /98 ⁷ / ₈ /113 ³ / ₈ " | → Fenix-NTM® |
| | 177/214/251 cm 69 ³ / ₄ /84 ² / ₈ /98 ⁷ / ₈ " | → DEKTON® |
| | 200 cm 78 ³ / ₄ " | → Fenix-NTM® → DEKTON® |
| | 200/237/274 cm 78 ³ / ₄ /93 ¹ / ₄ /107 ⁷ / ₈ " | → Fenix-NTM® |
| | 200/237/274 cm 78 ³ / ₄ /93 ¹ / ₄ /107 ⁷ / ₈ " | → DEKTON® |
| | 220 cm 86 ⁵ / ₈ " | → Fenix-NTM® |
| 220/257/294 cm 86 ⁵ / ₈ /101 ² / ₈ /116 ¹ / ₈ " | → Fenix-NTM® | |

Prof. 90 cm
Prof. 35³/₈"

| | | |
|----|---|--------------|
| 90 | 161 cm 63 ³ / ₈ " | → Fenix-NTM® |
| | 180 cm 70 ⁷ / ₈ " | → Fenix-NTM® |
| | 215 cm 84 ⁵ / ₈ " | → Fenix-NTM® |
| | 270 cm 106 ² / ₈ " | → Fenix-NTM® |

Banco

Prof. 41 cm
Prof. 16¹/₈"

| | | |
|----|--|--------------|
| 41 | 123 cm 48 ³ / ₈ " | → Fenix-NTM® |
| | 144 cm 56 ³ / ₄ " | → Fenix-NTM® |
| | 162 cm 63 ⁷ / ₈ " | → Fenix-NTM® |

Prof. 100 cm
Prof. 39³/₈"

| | | |
|-----|--|---------------------------|
| 100 | 177 cm 69 ³ / ₄ " | → Fenix-NTM® → DEKTON® |
| | 177/224/271 cm 69 ³ / ₄ /88 ² / ₈ /106 ³ / ₄ " | → Fenix-NTM® |
| | 177/214/251 cm 69 ³ / ₄ /84 ² / ₈ /98 ⁷ / ₈ " | → DEKTON® |
| | 200 cm 78 ³ / ₄ " | → Fenix-NTM® → DEKTON® |
| | 200/247/294 cm 78 ³ / ₄ /97 ² / ₈ /115 ³ / ₄ " | → Fenix-NTM® |
| | 200/237/274 cm 78 ³ / ₄ /93 ¹ / ₄ /107 ⁷ / ₈ " | → DEKTON® |
| | 220 cm 86 ⁵ / ₈ " | → Fenix-NTM® |
| | 220/267/314 cm 86 ⁵ / ₈ /105 ¹ / ₈ /123 ³ / ₄ " | → Fenix-NTM® |
| | 240 cm 94 ⁴ / ₈ " | → DEKTON® |
| | 280 cm 110 ² / ₈ " | → DEKTON® |

* = 3ª prolongación adicional (bajo petición)

Sobres

Prof. 136 cm
Prof. 534/8"

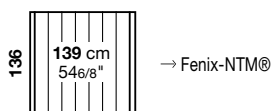

Fenix-NTM® borde negro Esp. 10 mm

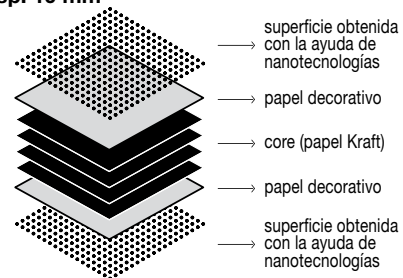
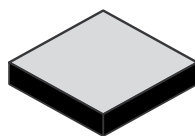

→ superficie obtenida con la ayuda de nanotecnologías
→ papel decorativo
→ core (papel Kraft)
→ papel decorativo
→ superficie obtenida con la ayuda de nanotecnologías

DEKTON® by Cosentino Esp. 8 mm

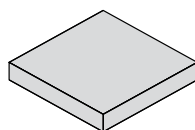

Dekton es una sofisticada mezcla de materias primas utilizadas para la creación de cristal, cerámica de última generación y superficies de cuarzo de altísima calidad

Sushi Fenix-NTM®

Extensible/Fija - Prof. 90 cm.

Acabado patas:

Aluminio anodizado

Aluminio barnizado blanco (parecido al Ral 9016)

Aluminio barnizado "Fenix-NTM® gris Londres" (parecido al Ral Design0805005)

Aluminio barnizado "Fenix-NTM® gris Bromo" (parecido al Ral 7012)

Aluminio barnizado negro (parecido al Ral 9004)

Aluminio barnizado verde oliva (ref. color "Poliuretano verde oliva PO08")

Acabado sobre/prolongaciones:

Fenix-NTM® borde negro (blanco Kos 0032, gris Londres 0718,

gris Bromo 0724, negro Ingo 0720)

→ En las mesas con códigos marcados con un asterisco (*) existe la posibilidad de añadir la tercera prolongación para alargarlas todavía más.

→ Atención: las medidas o los acabados marcados con (!) tienen los tiempos de producción más largos, de aproximadamente 6 semanas desde la fecha del pedido.

→ Las mesas que superan los 250 cm extendidas presentan una ligera flexión del sobre que respeta los estándares de calidad aceptados.

→ Embalajes reforzados, ver lado interno de la portada.

→ Funda de protección "Casper" ver pág. 74.

Extensible (►)

| Código | Longitud (L) | Prof. | Patas | Sobre | Precios EURO | Packs | Vol. m ³ | Kg |
|----------|---|-------|-----------|-----------------------|--------------|-------|---------------------|----|
| 01SUS07* | 150-187-224 | 90 | aluminio | Fenix borde negro | | 3 | 0,41 | 71 |
| | | | barnizado | Fenix borde negro | | | | |
| 01SUS06 | 177-214-251-288 <small>Tercera prolongación de serie</small> | 90 | aluminio | Fenix borde negro | | 4 | 0,5 | 81 |
| | | | barnizado | Fenix borde negro | | | | |
| 01SUS09* | 200-237-274 | 90 | aluminio | Fenix borde negro | | 3 | 0,51 | 82 |
| | | | barnizado | Fenix borde negro | | | | |
| 01SUS35* | 220-257-294 | 90 | aluminio | Fenix borde negro (!) | | 3 | 0,55 | 88 |
| | | | barnizado | Fenix borde negro (!) | | | | |

(*) 3ª prolongación adicional

| Código | Longitud (L) | Prolongación | Precios EURO | Packs | Vol. m ³ | Kg |
|----------|--------------|-------------------|--------------|-------|---------------------|-----|
| 50SUS02A | 37,5 | Fenix borde negro | | 1 | 0,025 | 6,5 |

Fija (II)

| Código | Longitud (L) | Prof. | Patas | Sobre | Precios EURO | Packs | Vol. m ³ | Kg |
|----------|--------------|-------|-----------|-----------------------|--------------|-------|---------------------|----|
| 01SUS07F | 150 | 90 | aluminio | Fenix borde negro | | 1 | 0,36 | 46 |
| | | | barnizado | Fenix borde negro | | | | |
| 01SUS06F | 177 | 90 | aluminio | Fenix borde negro | | 1 | 0,42 | 52 |
| | | | barnizado | Fenix borde negro | | | | |
| 01SUS64F | 200 | 90 | aluminio | Fenix borde negro | | 1 | 0,46 | 57 |
| | | | barnizado | Fenix borde negro | | | | |
| 01SUS35F | 220 | 90 | aluminio | Fenix borde negro (!) | | 1 | 0,5 | 62 |
| | | | barnizado | Fenix borde negro (!) | | | | |

Opcionales

| Código | | Precios EURO | Packs | Vol. m ³ | Kg |
|---------|--|--------------|-------|---------------------|----|
| 02GTA02 |  corte pata a medida | | - | - | - |

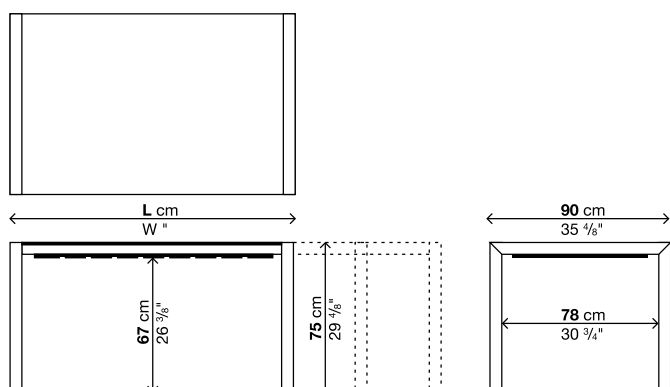

Sushi Fenix-NTM®

Extensible/Fija - Prof. 100 cm.

Acabado patas:

Aluminio anodizado

Aluminio barnizado blanco (parecido al Ral 9016)

Aluminio barnizado "Fenix-NTM® gris Londres" (parecido al Ral Design0805005)

Aluminio barnizado "Fenix-NTM® gris Bromo" (parecido al Ral 7012)

Aluminio barnizado negro (parecido al Ral 9004)

Aluminio barnizado verde oliva (ref. color "Poliuretano verde oliva PO08")

Acabado sobre:

Fenix-NTM® borde negro (blanco Kos 0032, gris Londres 0718,

gris Bromo 0724, negro Ingo 0720)

→ En las mesas con códigos marcados con un asterisco (*) existe la posibilidad de añadir la tercera prolongación para alargarlas todavía más.

→ Las mesas que superan los 250 cm extendidas presentan una ligera flexión del sobre que respeta los estándares de calidad aceptados.

→ Embalajes reforzados, ver lado interno de la portada.

→ **Funda de protección "Casper" ver pág. 74.**

Extensible (►)

| Código | Longitud (L) | Prof. | Patas | Sobre | Precios EURO | Packs | Vol. m³ | Kg |
|----------|--------------|-------|-----------|-------------------|--------------|-------|---------|----|
| 01SUS02* | 177-224-271 | 100 | aluminio | Fenix borde negro | | 3 | 0,52 | 85 |
| | | | barnizado | Fenix borde negro | | | | |
| 01SUS36* | 200-247-294 | 100 | aluminio | Fenix borde negro | | 3 | 0,57 | 92 |
| | | | barnizado | Fenix borde negro | | | | |
| 01SUS05* | 220-267-314 | 100 | aluminio | Fenix borde negro | | 3 | 0,62 | 98 |
| | | | barnizado | Fenix borde negro | | | | |

(*) 3ª prolongación adicional

| Código | Longitud (L) | Prolongación | Precios EURO | Packs | Vol. m³ | Kg |
|----------|--------------|-------------------|--------------|-------|---------|----|
| 50SUS06A | 33 | Fenix borde negro | | 1 | 0,036 | 6 |

Fija (II)

| Código | Longitud (L) | Prof. | Patas | Sobre | Precios EURO | Packs | Vol. m³ | Kg |
|----------|--------------|-------|-----------|-------------------|--------------|-------|---------|----|
| 01SUS02F | 177 | 100 | aluminio | Fenix borde negro | | 1 | 0,45 | 56 |
| | | | barnizado | Fenix borde negro | | | | |
| 01SUS08F | 200 | 100 | aluminio | Fenix borde negro | | 1 | 0,5 | 62 |
| | | | barnizado | Fenix borde negro | | | | |
| 01SUS05F | 220 | 100 | aluminio | Fenix borde negro | | 1 | 0,55 | 67 |
| | | | barnizado | Fenix borde negro | | | | |

Opcionales

| Código | | | Precios EURO | Packs | Vol. m³ | Kg |
|---------|--|---------------------|--------------|-------|---------|----|
| 02GTA02 |  | corte pata a medida | - | - | - | - |

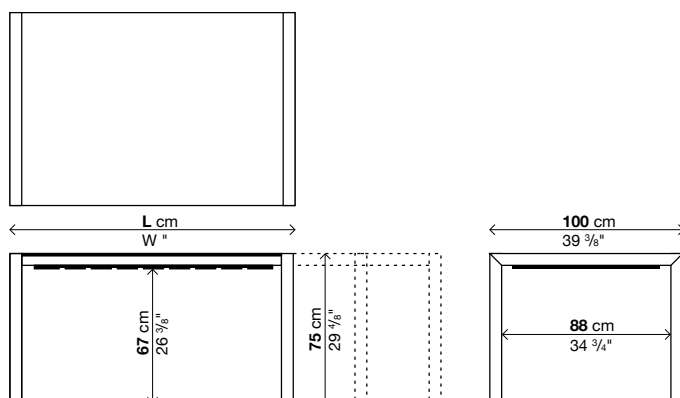

Sushi DEKTON® by Cosentino

Extensible/Fija - Prof. 90/100 cm.

Acabado patas:

Aluminio anodizado

Aluminio barnizado blanco (parecido al Ral 9016)

Aluminio barnizado "gris Ventus"

Aluminio barnizado verde oliva (ref. color "Poliuretano verde oliva PO08")

Acabado sobre:

DEKTON® blanco Zenith

DEKTON® gris Ventus

DEKTON® Aura (mármol digital)

Acabado prolongaciones:

Aluminio barnizado blanco (parecido al Ral 9016)

Aluminio barnizado "gris Ventus"

→ Atención: los veteados reproducidos sobre la superficie de los sobres de DEKTON® Aura (mármol digital) están dispuestos de modo casual, peculiaridad que hace que cada sobre resulte único e irrepetible. Esta característica implica posibles diferencias respecto a las muestras, que no pueden considerarse como imperfecciones o anomalías objeto de reclamación. Debido a la casualidad de su disposición, no es posible obtener bajo pedido veteados más o menos homogéneos.

→ Atención: las medidas o los acabados marcados con (!) tienen los tiempos de producción más largos, de aproximadamente 6 semanas desde la fecha del pedido.

→ Las mesas que superan los 250 cm extendidas presentan una ligera flexión del sobre que respeta los estándares de calidad aceptados.

→ Embalajes reforzados, ver lado interno de la portada.

→ Funda de protección "Casper" ver pág. 74.

Extensible (►)

| Código | Longitud (L) | Prof. | Patatas | Sobre | Precios EURO | Packs | Vol. m ³ | Kg |
|---------|--------------|-------|-----------|------------|--------------|-------|---------------------|-----|
| 01SUS07 | 150-187-224 | 90 | aluminio | DEKTON (!) | | 3 | 0,41 | 89 |
| | | | barnizado | DEKTON (!) | | | | |
| 01SUS06 | 177-214-251 | 90 | aluminio | DEKTON (!) | | 3 | 0,5 | 102 |
| | | | barnizado | DEKTON (!) | | | | |
| 01SUS09 | 200-237-274 | 90 | aluminio | DEKTON (!) | | 3 | 0,51 | 105 |
| | | | barnizado | DEKTON (!) | | | | |
| 01SUS02 | 177-214-251 | 100 | aluminio | DEKTON (!) | | 3 | 0,52 | 108 |
| | | | barnizado | DEKTON (!) | | | | |
| 01SUS36 | 200-237-274 | 100 | aluminio | DEKTON (!) | | 3 | 0,57 | 118 |
| | | | barnizado | DEKTON (!) | | | | |

Fija (II)

| Código | Longitud (L) | Prof. | Patatas | Sobre | Precios EURO | Packs | Vol. m ³ | Kg |
|----------|--------------|-------|--------------------|------------|--------------|-------|---------------------|-----|
| 01SUS07F | 150 | 90 | aluminio barnizado | DEKTON (!) | | 1 | 0,36 | 60 |
| 01SUS06F | 177 | 90 | aluminio barnizado | DEKTON (!) | | 1 | 0,42 | 69 |
| 01SUS64F | 200 | 90 | aluminio barnizado | DEKTON (!) | | 1 | 0,46 | 76 |
| 01SUS02F | 177 | 100 | aluminio barnizado | DEKTON (!) | | 1 | 0,45 | 74 |
| 01SUS08F | 200 | 100 | aluminio barnizado | DEKTON (!) | | 1 | 0,5 | 83 |
| 01SUS09F | 240 | 100 | aluminio barnizado | DEKTON (!) | | 1 | 0,6 | 97 |
| 01SUS82F | 280 | 100 | aluminio barnizado | DEKTON (!) | | 1 | 0,69 | 115 |

Opcionales

| Código | Prof | | Precios EURO | Packs | Vol. m ³ | Kg |
|---------|------|---------------------|--------------|-------|---------------------|----|
| 02GTA02 | | corte pata a medida | | - | - | - |

