

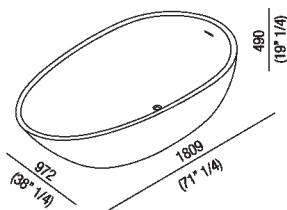

Bathtub  
 AVAS0916\_

design Benedini Associati, 2005

Deep free-standing bathtub in Cristalplant®  
 biobased.



**Finishes**

-  White
-  White/dark grey
-  White/light grey

**Materials**

-  Cristalplant® biobased

Oval bathtub made from white Cristalplant® biobased or two coloured (exterior in dark grey RAL7021 or light grey RAL 7044); with overflow, without tap holes. Taps can be wall or floor mounted. The bathtub must be fitted with waste trap .MET0477 or .MET0477C (.MET0434 or .MET0477C for display tubs). The two-coloured model can be made in colours chosen by the client with a surcharge of 15% on the price of the two-coloured finish. For an easier installation of the bathtubs we recommend to use the template for the positioning of the waste trap AKITPZVAS.

Height:	49 cm	19" 1/4 inches
Length:	180.9 cm	71" 1/4 inches
Weight:	115 kg	254 lbs
Depth:	97.2 cm	38" 1/4 inches
Capacity:	320 l	84 gal
Packaging:	111 x 193 x 68 cm	43" 6/8 x 76" x 26" 6/8 inches
Total weight:	163 kg	360 lbs



Main dimensions

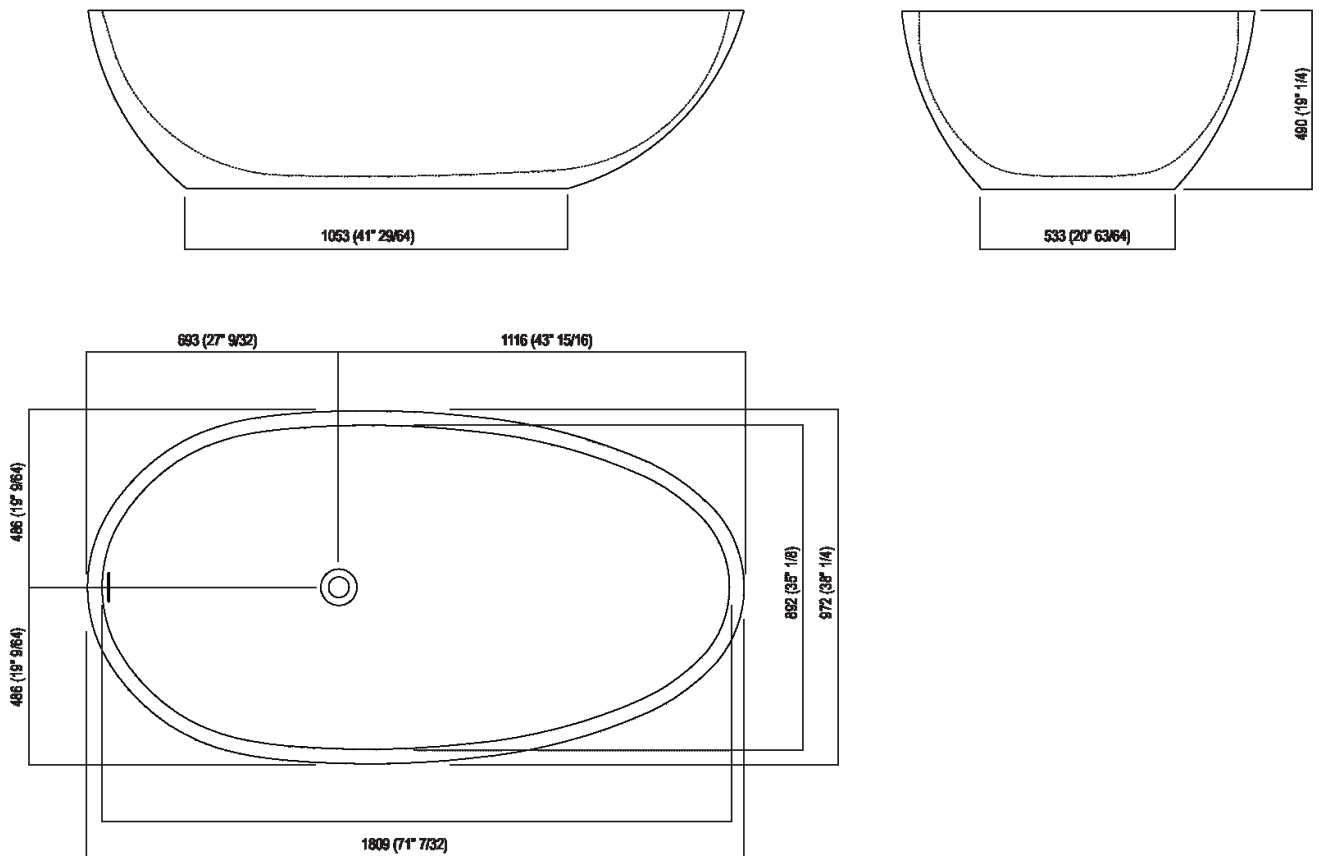



Dimensions for recess

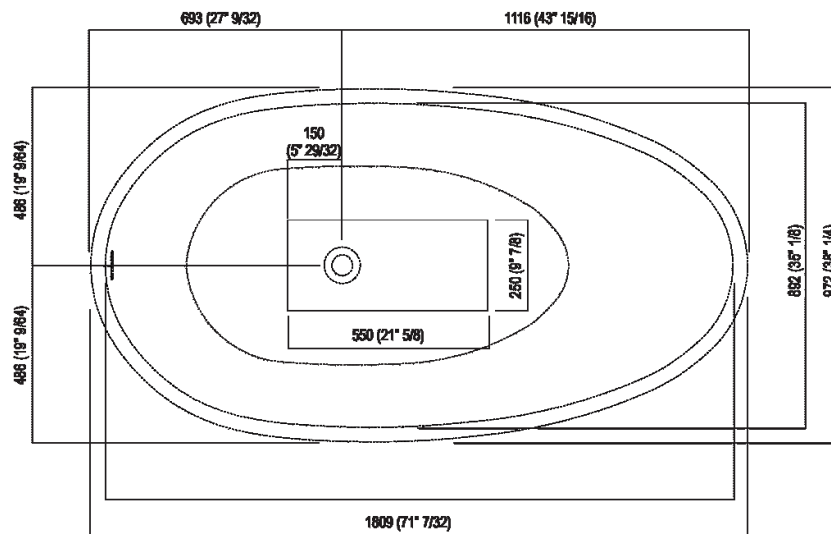



Dimensions for freestanding spouts

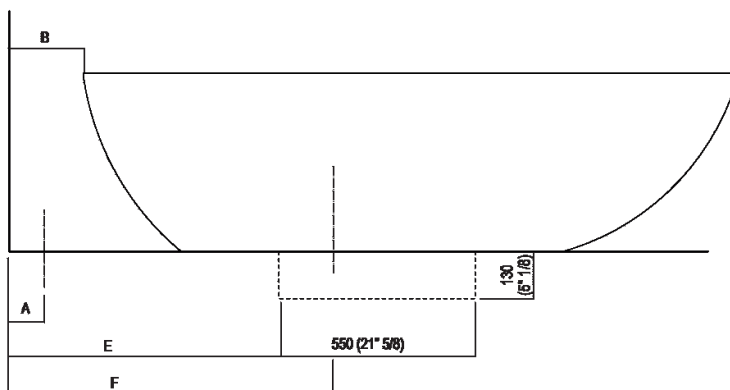
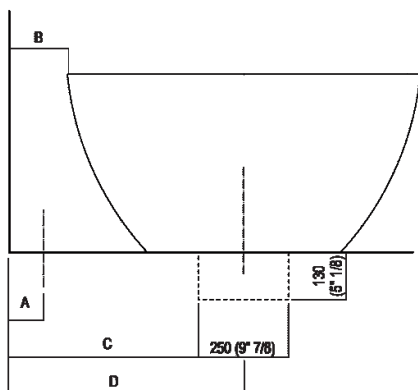

	A	B	C	D	E	F
FEZ (ARUB140, RAUB145, ARUB170N)	80 (3 <sup>1</sup> / <sub>8</sub> )	200 (7 <sup>7</sup> / <sub>8</sub> )	567 (22 <sup>5</sup> / <sub>16</sub> )	692 (27 <sup>1</sup> / <sub>4</sub> )	743 (29 <sup>1</sup> / <sub>4</sub> )	893 (35 <sup>3</sup> / <sub>16</sub> )
MEMORY (ARUB1078, ARUB1072, ARUB1033)	80 (3 <sup>1</sup> / <sub>8</sub> )	200 (7 <sup>7</sup> / <sub>8</sub> )	567 (22 <sup>5</sup> / <sub>16</sub> )	692 (27 <sup>1</sup> / <sub>4</sub> )	743 (29 <sup>1</sup> / <sub>4</sub> )	893 (35 <sup>3</sup> / <sub>16</sub> )
SQUARE (ARUB0961L, ARUB0934L, ARUB0935NL, ARUB0936NL, ARUB0952L, ARUB1024N, ARUB1112, ARUB1115)	80 (3 <sup>1</sup> / <sub>8</sub> )	165 (6 <sup>1</sup> / <sub>5</sub> )	507 (20 <sup>0</sup> )	657 (27 <sup>5</sup> / <sub>8</sub> )	708 (27 <sup>7</sup> / <sub>8</sub> )	858 (33 <sup>3</sup> / <sub>4</sub> )
SEN (ASEN0911)	80 (3 <sup>1</sup> / <sub>8</sub> )	165 (6 <sup>1</sup> / <sub>5</sub> )	532 (20 <sup>15</sup> / <sub>16</sub> )	657 (27 <sup>5</sup> / <sub>8</sub> )	708 (27 <sup>7</sup> / <sub>8</sub> )	858 (33 <sup>3</sup> / <sub>4</sub> )



Dimensions for wall mounted taps

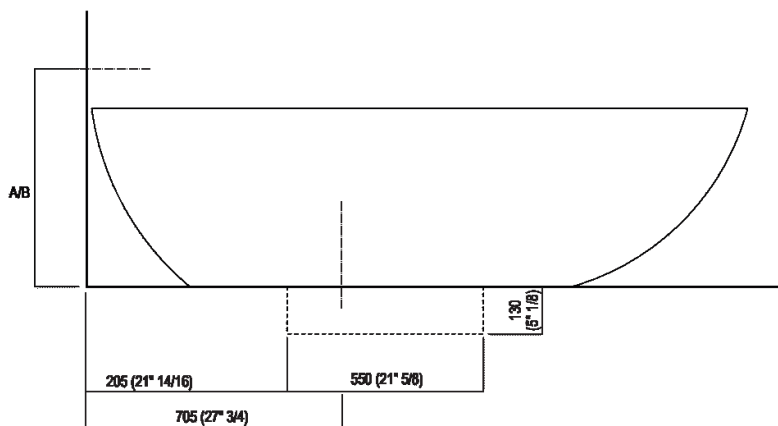
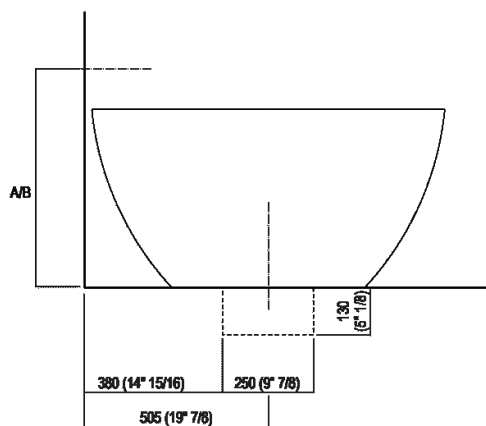

	A*	B**
FEZ (ARUB050000L, ARUB051000L, ARUB150000C, ARUB151000C, ARUB1089S, ARUB190000C, ARUB191000C, ARUB1091S)	590 (23 1/4)	-
MEMORY (ARUB1076S, ARUB1077S, ARUB1040S)	590 (23 1/4)	-
SQUARE (ARUB0932N, ARUB0933N, ARUB1117)	-	590 (23 1/4)
SEN (ASEN0912V)	-	590 (23 1/4)

\* Insieme gruppo / axial distance for tap  
 \*\* filo inferiore gruppo / Tap's lower edge



Dimensions for tap support

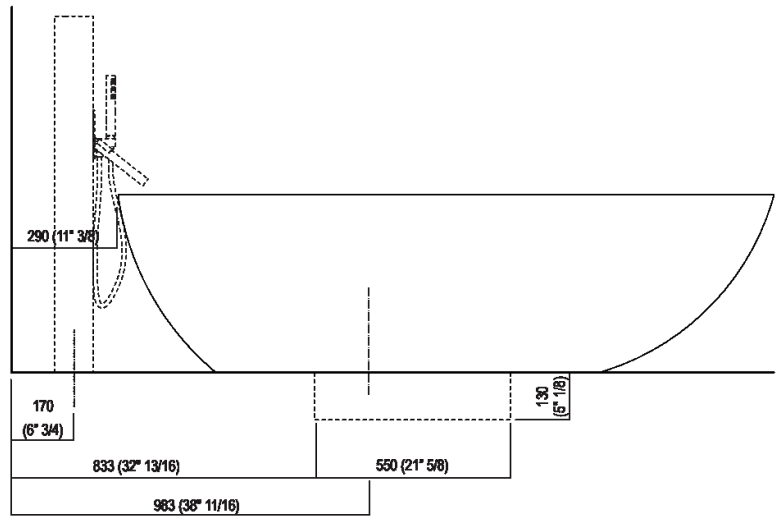
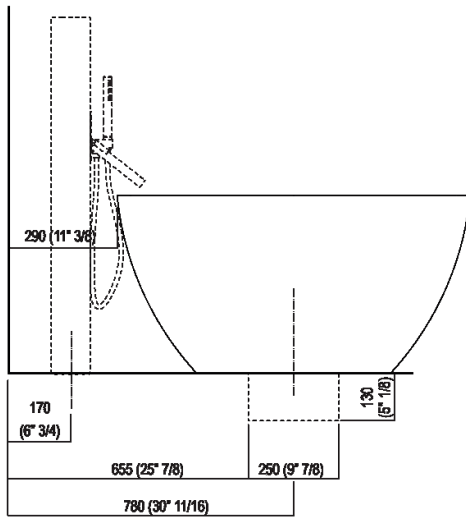



Note

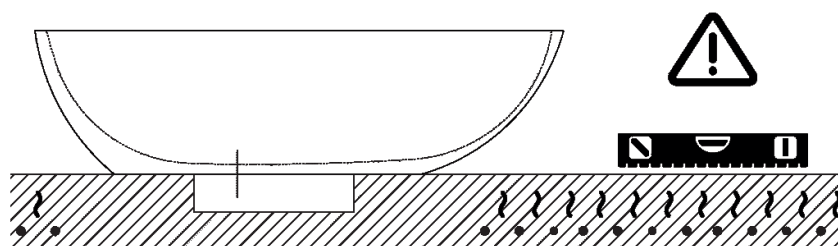

**La vasca deve essere installata su un pavimento perfettamente piano.  
The bathtub must be positioned on a flat floor surface.**

**E' necessario predisporre a pavimento un pozzetto.  
It is necessary to prepare a recess in the floor.**

**Evitare di realizzare impianti di riscaldamento nell'area sottostante la vasca.  
Avoid the installation of floor heating plants in the area under the bathtub.**