

---

# Amoenus Soft

SOFAS

*Antonio Citterio*



Description

---

# Technical information

## Internal frame

tubular steel and steel profiles

## Internal frame upholstery

Bayfit® flexible cold shaped polyurethane foam, shaped polyurethane, polyester fibre cover

## Internal frame upholstery (AM170G)

Bayfit® flexible cold shaped polyurethane foam, shaped polyurethane, polyester fibre cover with polyester fibre seat upholstery

## Internal frame upholstery (AM110P-AM154P)

shaped polyurethane of different density, polyester fibre cover

## Seat cushion upholstery

shaped polyurethane of different density, sterilized down, polyester fibre cover

## Back cushion (AM60C-AM90C)

down feather, box style typology

## Lower edge

die-cast aluminium and extrusions

## Feet

thermoplastic material

## Wheels (AM170G)

plastic material

## Cover

fabric (eco-leather profiles) or leather (envelope stitching)

# Technical drawings

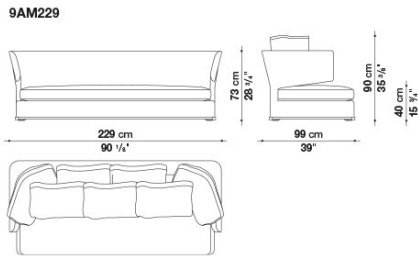

**9AM229**

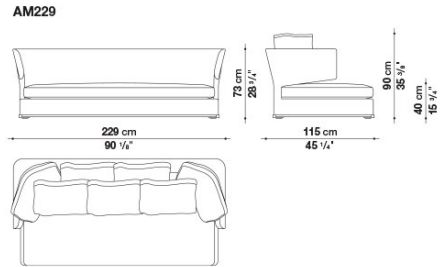

**AM229**

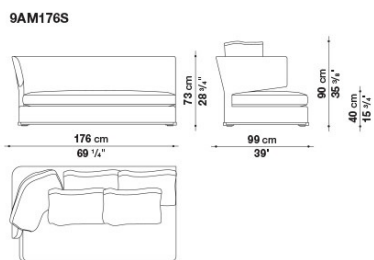

**9AM176S**

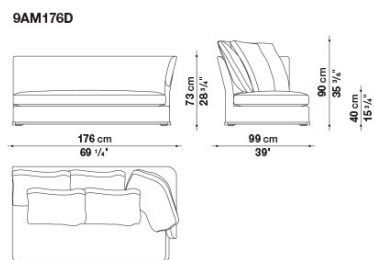

**9AM176D**

AM175LS

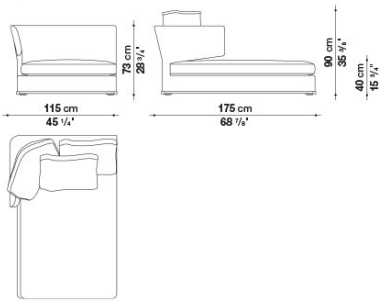

AM175LS

AM175LD

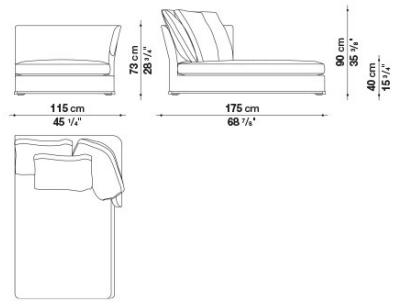

AM175LD

AM170G

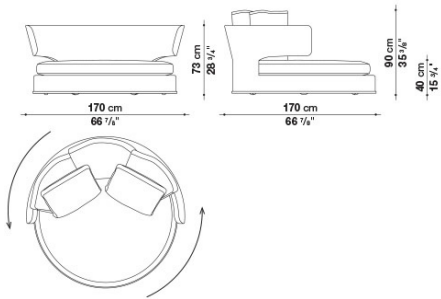

AM170G

AM110P

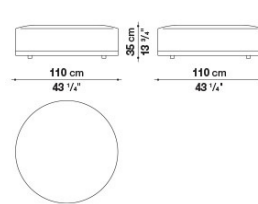

AM110P

AM154P

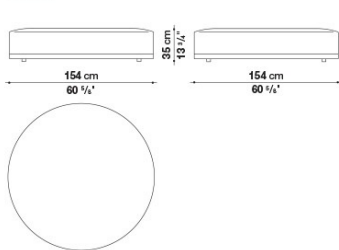

AM154P

---

B&B Italia reserves the right to make technological and aesthetic improvements to its models, including changes to the sizes and materials, without notice. The technical drawings do not define the details of the product. The measurements shown are indicative and may undergo changes. In particular, the dimensions relevant to the padded parts are subject to usage tolerances over time caused by the normal adjustment of the padding. For the specific information, please contact the dealer closest to you.